



Experts in Custom Lighting
and Project Management

ABOUT US

Experts in Custom Lighting and Project Management



Anno Lighting, based in Guangdong, China, is a lighting company that excels in providing tangible lighting products and project management services. Our strengths lie in:

- 1. Custom Lighting Solutions:** Our design team is not only rich in creativity but also adept at turning these ideas into practical products. Whether it's a residential lighting with a unique design or corporate lighting with specific functionalities, we can tailor lighting solutions to meet our clients' precise needs. Our products undergo strict quality control to ensure that every item delivered to our clients is reliable and durable.
- 2. Efficient Project Management:** We understand that timely and quality project completion is crucial for our clients. Therefore, we have established a rigorous project management system, with clear timelines and responsible individuals at every stage from initiation to delivery. Our project management team maintains close communication with clients, ensuring transparency in project progress and promptly addressing any issues that may arise, to ensure smooth project advancement.
- 3. Comprehensive Scene Solutions:** We offer more than just individual lighting products; we provide holistic lighting solutions for specific scenes. Whether it's a hotel lobby, office space, or retail supermarket, we offer a one-stop service from design to installation. We focus on harmonizing lighting with the space, striving to enhance the aesthetics and user experience while fulfilling lighting functionalities.

At Anno Lighting, we believe that lighting is not just about providing illumination but also about creating comfortable, efficient, and aesthetically pleasing living and working environments. Our goal is to offer valuable and effective lighting solutions through a pragmatic approach and professional services, delivering tangible benefits to our clients.

CERTIFICATE

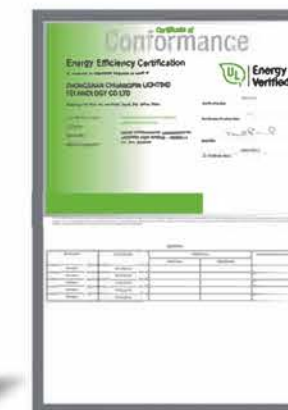
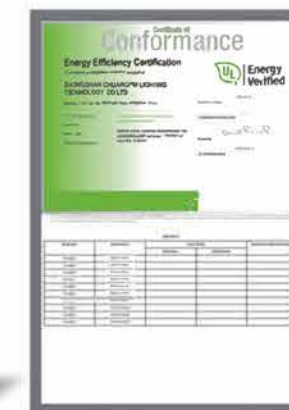

Overviews

LED Panel Lights



LED Gimbal Downlights



LED Downlights



Overviews

LED Commercial Downlights



LED Disk Lights



LED Retrofit Downlights



LED Ceiling Lights



LED Track Light



LED Grille Linear Lights



Pendent Track Lights



Mounting Plates



LED Pot Light - PC125

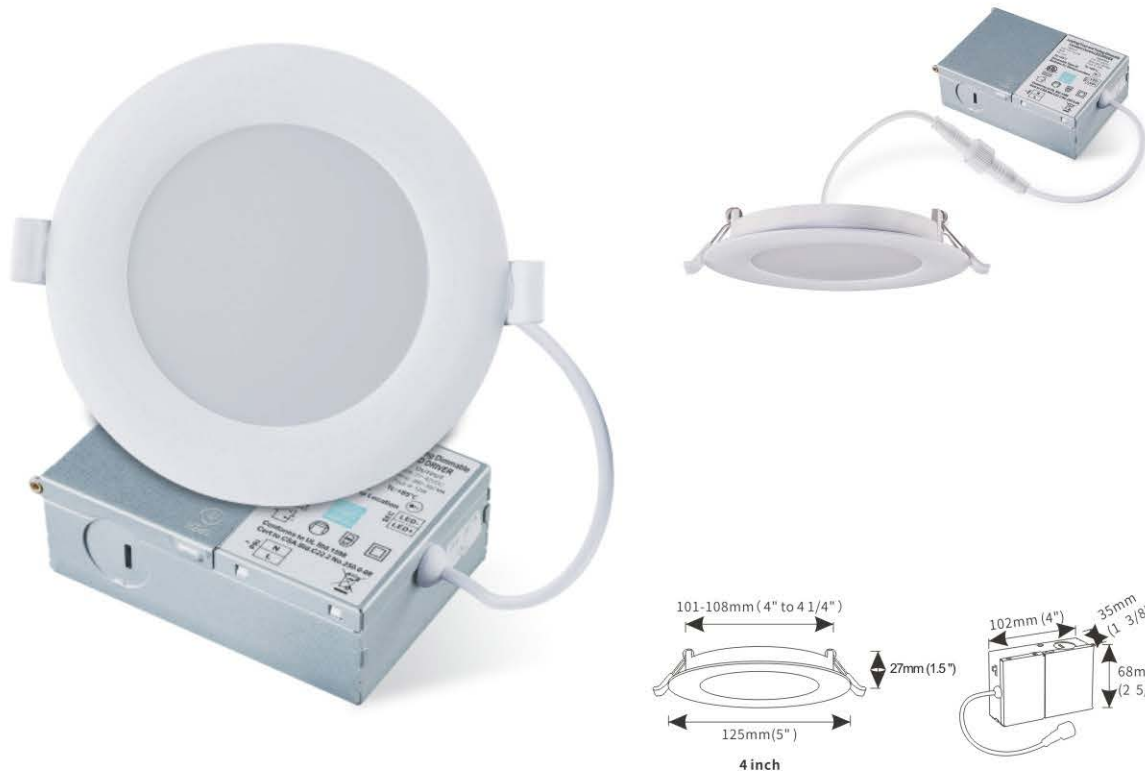

Plastic Trim

| Model | Size | LED Chips | Watt(W) | Input Voltage | Efficacy lm/w | Beam Angle | CRI | Color Temp(K) | Lifespan (hrs) | Dimmable |
|-------|--------|-----------|---------|----------------------------------|---------------|------------|-----------|---------------|----------------|----------|
| PC125 | 4 inch | SMD | 9 | 100-130V 100-277V 100-347V | 90 | 110° | Ra80/Ra90 | 2700-6000 | 50000 | Yes |



- Trim Finish: White, Black, Brush Nickel, Chrome (Aluminum Body)
- Air Tight & IC Rated
- High Efficiency
- Driver Type: Constant Current



- IC Rated Junction Box-UL Isolated Driver(Aluminum/Iron, Metal Junction Box Optional)
- 3 CCT Adjusted by DIP Switch: 30K/40K/50K
- 5 CCT Adjusted by DIP Switch: 27K/30K/40K/50K/60K
- 3 CCT Adjusted by DIP Switch and Wall Switch Control: 30K/40K/50K
- 5 CCT Adjusted by DIP Switch and Wall Switch Control: 27K/30K/35K/40K/50K



LED Pot Light - P021



Edge-lit

| Model | Size | LED Chips | Watt(W) | Input Voltage | Efficacy lm/w | Beam Angle | CRI | Color Temp(K) | Lifespan (hrs) | Dimmable |
|-------|--------|-----------|---------|----------------------------------|---------------|------------|-----------|---------------|----------------|----------|
| P021 | 4 inch | SMD | 9 | 100-130V 100-277V 100-347V | 90 | 120° | Ra80/Ra90 | 2700-6000 | 50000 | Yes |

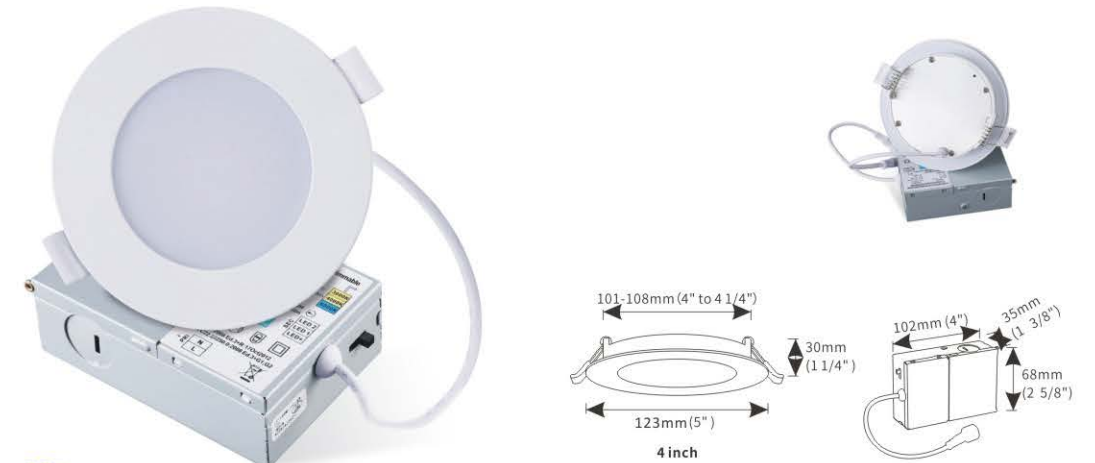

Back-lit

| Model | Size | LED Chips | Watt(W) | Input Voltage | Efficacy lm/w | Beam Angle | CRI | Color Temp(K) | Lifespan (hrs) | Dimmable |
|-------|--------|-----------|---------|----------------------------------|---------------|------------|-----------|---------------|----------------|----------|
| P021 | 4 inch | SMD | 9 | 100-130V 100-277V 100-347V | 90 | 120° | Ra80/Ra90 | 2700-6000 | 50000 | Yes |

| | | | |
|------------------------------|---|--|--|
| Size: | 4inch (123mm) | Driver Type: | Constant Current |
| Power: | 9W | Available Color Temperature: | 2700K-6500K |
| Power Factor: | >0.9 | IP Grade: | Damp Location / Wet Location |
| Color Quality CRI: | >80 / >90 | Air Tight: | Yes |
| Beam Angle : | 120° | Material: | Aluminum+PC |
| LED Chips: | SMD | Operating Temperature: | Farenheit :-4°F to +104°F Celcius :-20°C to +40°C |
| Luminous Efficacy: | 90-100LM/W | IC Rated Fixture And Driver: | Yes |
| Default Driver Input: | AC:100-130V / 100-277V (Dimmable) 100-347V 60 Hz Triac / 0-10V DIM | (Contact With Insulation Allowed) | |



- Trim Finish: White, Black, Brush Nickel, Chrome (Aluminum Body)
- Air Tight & IC Rated
- High Efficiency
- Driver Type: Constant Current



ULTRA-THIN LED PANEL LIGHTS
100-130V TRIAC DIMMABLE / 100-277V / 100-347V 0-10V DIMMABLE



| Model | Size | LED Chips | Watt(W) | Input Voltage | Efficacy lm/w | Beam Angle | CRI | Color Temp(K) | Lifespan (hrs) | Dimmable |
|---------|---------|-----------|---------|----------------------------------|---------------|------------|-----------|---------------|----------------|----------|
| P02103 | 3 inch | SMD | 5 | 100-130V 100-277V 100-347V | 90 | 120° | Ra80/Ra90 | 2700-6000 | 50000 | Yes |
| P02104 | 4inch | | 9 | | | | | | | |
| P02105 | 5inch | | 10 | | | | | | | |
| P02106 | 6inch | | 12 | | | | | | | |
| P02107 | 7inch | | 15 | | | | | | | |
| P02108 | 8inch | | 18 | | | | | | | |
| P021085 | 8.5inch | | 20-25 | | | | | | | |
| P02111 | 11inch | | 24 | | | | | | | |

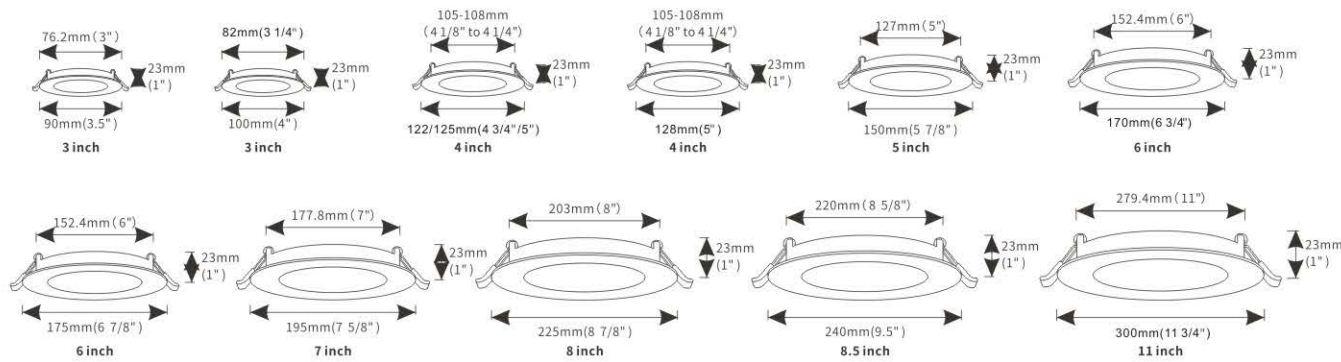

- Trim Finish: White, Black, Brush Nickel, Chrome (Aluminum Body)
- Air Tight & IC Rated
- High Efficiency
- Driver Type: Constant Current



| Model | Size | LED Chips | Watt(W) | Input Voltage | Efficacy lm/w | Beam Angle | CRI | Color Temp(K) | Lifespan (hrs) | Dimmable |
|---------|---------|-----------|---------|----------------------------------|---------------|------------|-----------|---------------|----------------|----------|
| P02203 | 3 inch | SMD | 5 | 100-130V 100-277V 100-347V | 90 | 120° | Ra80/Ra90 | 2700-6000 | 50000 | Yes |
| P02204 | 4inch | | 9 | | | | | | | |
| P02205 | 5inch | | 9-12 | | | | | | | |
| P02206 | 6inch | | 12 | | | | | | | |
| P02207 | 7inch | | 15-18 | | | | | | | |
| P02208 | 8inch | | 18 | | | | | | | |
| P022085 | 8.5inch | | 20-25 | | | | | | | |
| P02211 | 11inch | | 24 | | | | | | | |

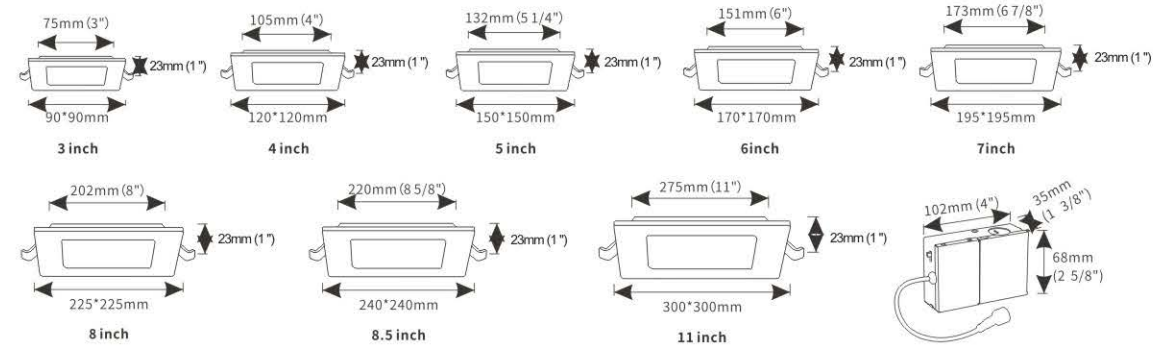

- Trim Finish: White, Black, Brush Nickel, Chrome, Golden and Bronze (Aluminum Body)
- Air Tight & IC Rated
- High Efficiency
- Driver Type: Constant Current



LED RECESSED POT LIGHT 5CCT WITH NIGHT LIGHT



Night Light: 2200K / 1800-3000K / 1800-4000K (Dim to Warm)
RGBCW / GREEN / BLUE / PINK / PURPLE.



| Model | Size | LED Chips | Watt(W) | Input Voltage | Efficacy lm/w | Beam Angle | CRI | Color Temp(K) | Lifespan (hrs) | Dimmable |
|--------|--------|-----------|---------|----------------------|---------------|------------|-----------|---------------|----------------|----------|
| P02104 | 4 inch | SMD | 9W+3W | 100-130V 100-277V | 90 | 120° | Ra80/Ra90 | 2700-6000 | 50000 | Yes |
| P02106 | 6 inch | SMD | 12W+3W | 100-347V | 90 | 120° | Ra80/Ra90 | 2700-6000 | 50000 | Yes |

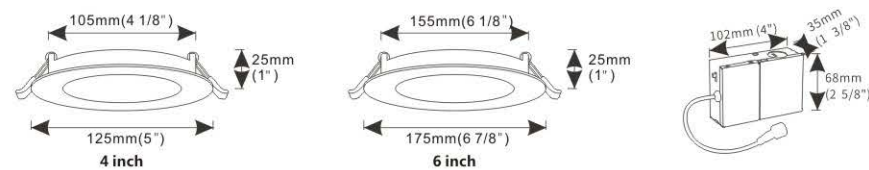

- Trim Finish: White, Black, Brush Nickel, Chrome, Golden and Bronze (Aluminum Body)
- Air Tight & IC Rated
- High Efficiency
- Driver Type: Constant Current



LED FIRE RATED RECESSED DOWNLIGHT UL L505 CEILING (TWO LAYERS)



- CLASS A FIRE RATED PAINTING MATERIAL
- AIR TIGHT RATED IC RATED
NO CAN OR ANY HOUSING REQUIRED
- FT6 CABLE
ISOLATED AND FLICKER FREE FCC DRIVER
- 2 HOUR FIRE RATING MODIFIED UL 263-2011(R2022)
ASTM E119-22/CAN/ULC-S101-14-REV1



FIRE RATED DOWNLIGHT

Fire rated accordance to UL 263 for up to 2 hours of protection from the passage of flames and toxic gases into ceiling plenums AIP-TITETM per ASTM E283

| Model | Size | LED Chips | Watt(W) | Input Voltage | Efficacy lm/w | Beam Angle | CRI | Color Temp(K) | Lifespan (hrs) | Dimmable |
|--------|--------|-----------|---------|----------------------|---------------|------------|-----------|---------------|----------------|----------|
| P02104 | 4 inch | SMD | 9 | 100-130V 100-277V | 90 | 120° | Ra80/Ra90 | 2700-6000 | 50000 | Yes |
| P02106 | 6 inch | SMD | 12 | 100-347V | 90 | 120° | Ra80/Ra90 | 2700-6000 | 50000 | Yes |

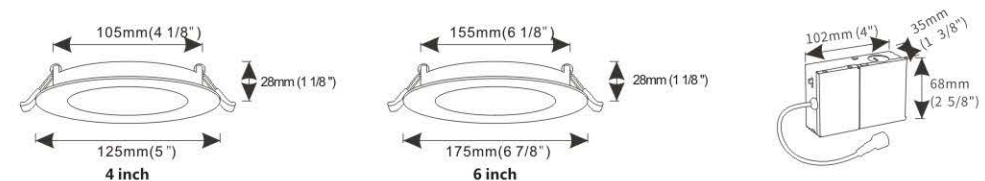

LED Pot Light - P023R8



P023R8-A baffle



P023R8-B flat



| Model | Size | LED Chips | Watt(W) | Input Voltage | Efficacy lm/w | Beam Angle | CRI | Color Temp(K) | Lifespan (hrs) | Dimmable |
|----------|--------|-----------|---------|----------------------|---------------|------------|-----------|---------------|----------------|----------|
| P023R8-A | 4 inch | SMD | 9 | 100-130V 100-277V | 90 | 120° | Ra80/Ra90 | 2700-6000 | 50000 | Yes |
| P023R8-B | 4 inch | SMD | 9 | 100-347V | 90 | 120° | Ra80/Ra90 | 2700-6000 | 50000 | Yes |

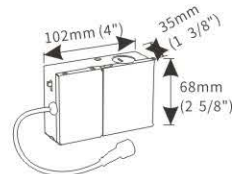
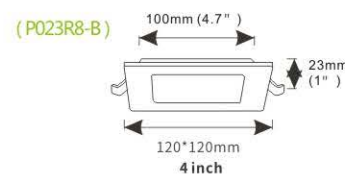
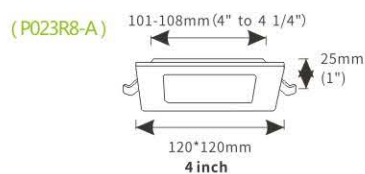

- Trim Finish: White, Black, Brush Nickel, Chrome (Aluminum Body)
- Air Tight & IC Rated
- High Efficiency
- Driver Type: Constant Current



- IC Rated Junction Box-UL Isolated Driver (Aluminum/Iron, Metal Junction Box Optional)
- 3CCT Adjusted by DIP Switch: 30K/40K/50K
- 5CCT Adjusted by DIP Switch: 27K/30K/40K/50K/60K
- 3CCT Adjusted by DIP Switch and Wall Switch Control: 30K/40K/50K
- 5CCT Adjusted by DIP Switch and Wall Switch Control: 27K/30K/35K/40K/50K

LED Pot Light - P023



Back-lit



| Model | Size | LED Chips | Watt(W) | Input Voltage | Efficacy lm/w | Beam Angle | CRI | Color Temp(K) | Lifespan (hrs) | Dimmable |
|---------|--------|-----------|---------|----------------------|---------------|------------|-----------|---------------|----------------|----------|
| P023R8 | 4 inch | SMD | 8-10 | 100-130V | 80-100 | 110° | Ra80/Ra90 | 2700-6500 | 50000 | Yes |
| P023R15 | 6 inch | SMD | 15-18 | 100-277V 100-347V | 80-100 | 110° | Ra80/Ra90 | 2700-6500 | 50000 | Yes |
| P023R18 | 8 inch | SMD | 18-20 | | 80-100 | 110° | Ra80/Ra90 | 2700-6500 | 50000 | Yes |

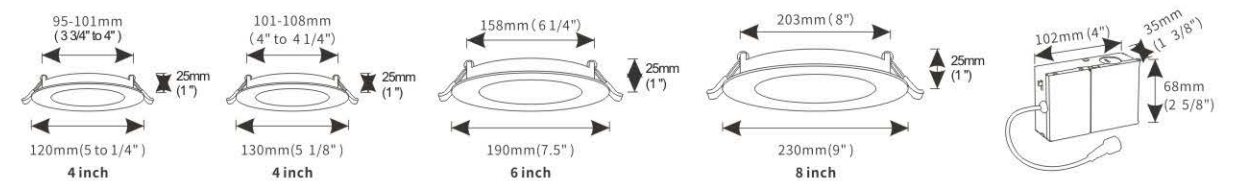

SMART EMERGENCY BATTERY BACKUP LED PANEL LIGHT



- 100-277V 0-10V DIM RA>90
- 5CCT Adjustable by DIP Switch
- Smart Sensor APP Control
- 2 Hours Emergency Time with Test Button

RGBCW

COLOR TEMPERATURE LED SMART LIGHT

- Color Adjustment
- Works with Amazon Alexa
- Smartphone Control
- iOS/Android
- Dimming
- Timer Mode



| Model | Size | LED Chips | Watt(W) | Input Voltage | Efficacy lm/w | Beam Angle | CRI | Color Temp(K) | Lifespan (hrs) | Dimmable |
|--------|--------|-----------|---------|----------------------|---------------|------------|-----------|---------------|----------------|----------|
| P02103 | 3 inch | SMD | 6 | | 90 | 120° | Ra80/Ra90 | RGBCW | 50000 | Yes |
| P02104 | 4 inch | SMD | 9 | 100-130V | 90 | 120° | Ra80/Ra90 | RGBCW | 50000 | Yes |
| P02106 | 6 inch | SMD | 12 | 100-277V 100-347V | 90 | 120° | Ra80/Ra90 | RGBCW | 50000 | Yes |
| P02108 | 8 inch | SMD | 18 | | 90 | 120° | Ra80/Ra90 | RGBCW | 50000 | Yes |

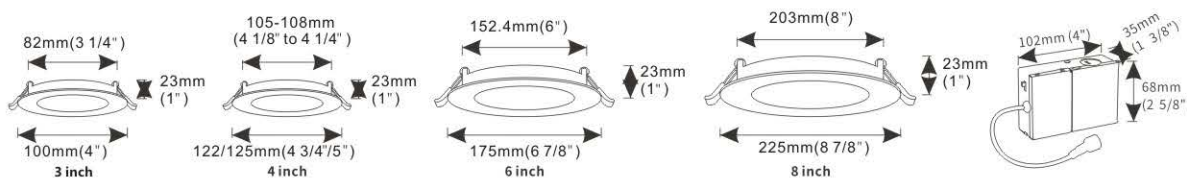

5CCT RECESSED SLIM PANEL LIGHT WITH BLUE LIGHT

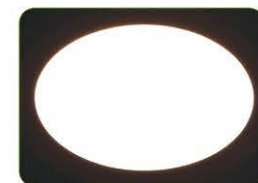

1. White Color Mode
Equivalent to ordinary panel lights



2. Blue Color Mode
Blue can create atmosphere more



3. Blue+White Mode
Three modes can be switched at any time



- Adjustable CCT
- IC RATED
- AIRTIGHT
- WET LOCATION
- Wall Switch

| Model | Size | LED Chips | Watt(W) | Input Voltage | Efficacy lm/w | Beam Angle | CRI | Color Temp(K) | Lifespan (hrs) | Dimmable |
|--------|--------|-----------|---------|----------------------------------|---------------|------------|-----------|---------------|----------------|----------|
| P02303 | 3 inch | SMD | 3+3W | | 90 | 120° | Ra80/Ra90 | 2700-6000 | 50000 | Yes |
| P02304 | 4 inch | SMD | 9+4W | | 90 | 120° | Ra80/Ra90 | 2700-6000 | 50000 | Yes |
| P02306 | 6 inch | SMD | 12+8W | 100-130V 100-277V 100-347V | 90 | 120° | Ra80/Ra90 | 2700-6000 | 50000 | Yes |
| P02308 | 8 inch | SMD | 18+6W | | 90 | 120° | Ra80/Ra90 | 2700-6000 | 50000 | Yes |

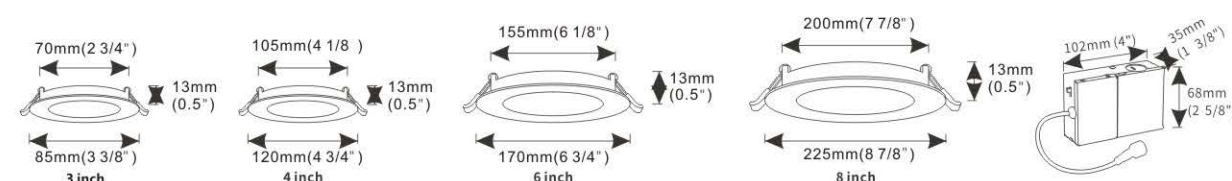



| Model | Size | LED Chips | Watt(W) | Input Voltage | Efficacy lm/w | Beam Angle | CRI | Color Temp(K) | Lifespan (hrs) | Dimmable |
|-------|----------|-----------|---------|----------------------|---------------|-------------|-----------|---------------|----------------|----------|
| C3205 | 3 inch | COB | 7 | 100-130V 100-277V | 90 | 15°/24°/36° | Ra80/Ra90 | 2700-6000 | 50000 | Yes |
| C4205 | 3.5 inch | COB | 7 | 100-347V | 90 | 15°/24°/36° | Ra80/Ra90 | 2700-6000 | 50000 | Yes |



| Model | Size | LED Chips | Watt(W) | Input Voltage | Efficacy lm/w | Beam Angle | CRI | Color Temp(K) | Lifespan (hrs) | Dimmable |
|-------|--------|-----------|---------|----------------------------------|---------------|-------------|-----------|---------------|----------------|----------|
| C3206 | 3 inch | COB | 7 | 100-130V 100-277V 100-347V | 90 | 15°/24°/36° | Ra80/Ra90 | 2700-6000 | 50000 | Yes |



- Trim Finish: White,Black,Brush Nickel.Chrome (Aluminum Body)
- Air Tight & IC Rated
- High Efficiency
- Driver Type: Constant Current



| Model | Size | LED Chips | Watt(W) | Input Voltage | Efficacy lm/w | Beam Angle | CRI | Color Temp(K) | Lifespan (hrs) | Dimmable |
|-------|--------|-----------|---------|----------------------|---------------|-------------|-----------|---------------|----------------|----------|
| C5205 | 4 inch | COB/SMD | 9 | 100-130V 100-277V | 90 | 15°/24°/36° | Ra80/Ra90 | 2700-6000 | 50000 | Yes |
| C5206 | 4 inch | COB/SMD | 9 | 100-347V | 90 | 15°/24°/36° | Ra80/Ra90 | 2700-6000 | 50000 | Yes |

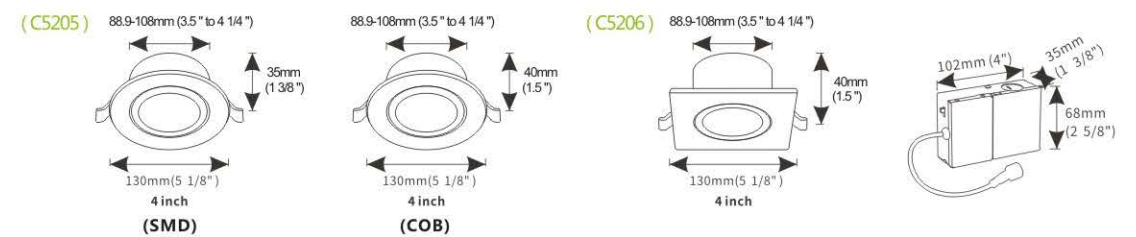

- Trim Finish: White,Black,Brush Nickel.Chrome (Aluminum Body)
- Air Tight & IC Rated
- High Efficiency
- Driver Type: Constant Current



- IC Rated Junction Box-UL Isolated Driver(Aluminum/Iron,Metal Junction Box Optional)
- 3CCT Adjusted by DIP Switch: 30K/40K/50K
- 5CCT Adjusted by DIP Switch: 27K/30K/40K/50K/60K
- 3CCT Adjusted by DIP Switch and Wall Switch Control: 30K/40K/50K
- 5CCT Adjusted by DIP Switch and Wall Switch Control: 27K/30K/35K/40K/50K





- Color Adjustment
- Works with Amazon Alexa
- Smartphone Control
- iOS/Android
- Dimming
- Timer Mode



| Model | Size | LED Chips | Watt(W) | Input Voltage | Efficacy lm/w | Beam Angle | CRI | Color Temp(K) | Lifespan (hrs) | Dimmable |
|-------------|--------|-----------|---------|----------------------|---------------|-------------|-----------|---------------|----------------|----------|
| C3205-RGBCW | 3 inch | COB | 7 | 100-130V 100-277V | 90 | 15°/24°/36° | Ra80/Ra90 | RGBCW | 50000 | Yes |
| C5205-RGBCW | 4 inch | COB | 9 | 100-347V | 90 | 15°/24°/36° | Ra80/Ra90 | RGBCW | 50000 | Yes |



- Trim Finish: White, Black, Brush Nickel, Chrome (Aluminum Body)
- Air Tight & IC Rated
- High Efficiency
- Driver Type: Constant Current

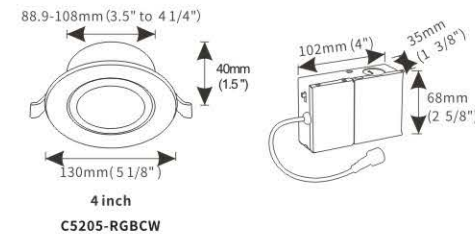
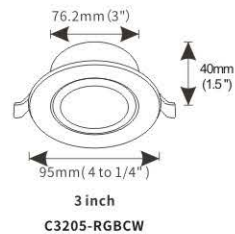

LP-TJ6235



LP-TJ6240



| Model | Size | LED Chips | Watt(W) | Input Voltage | Efficacy lm/w | Beam Angle | CRI | Color Temp(K) | Lifespan (hrs) | Dimmable |
|-----------|----------|-----------|---------|----------------------|---------------|-------------|-----------|---------------|----------------|----------|
| LP-TJ6235 | 3.5 inch | COB/SMD | 7 | 100-130V 100-277V | 90 | 15°/24°/36° | Ra80/Ra90 | 2700-6000 | 50000 | Yes |
| LP-TJ6240 | 4 inch | SMD | 9 | 100-277V 100-347V | 90 | 15°/24°/36° | Ra80/Ra90 | 2700-6000 | 50000 | Yes |

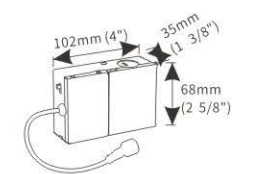
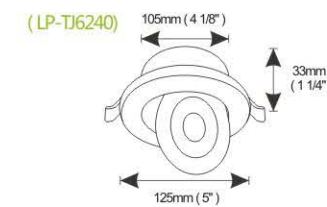
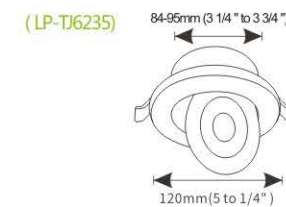

- Trim Finish: White, Black, Brush Nickel, Chrome (Aluminum Body)
- Air Tight & IC Rated
- High Efficiency
- Driver Type: Constant Current



LED Downlight - T5201C7



WHITE



BLACK



CHROME



| Model | Size | LED Chips | Watt(W) | Input Voltage | Efficacy lm/w | Beam Angle | CRI | Color Temp(K) | Lifespan (hrs) | Dimmable |
|---------|--------|-----------|---------|---------------|---------------|-------------|-----------|---------------|----------------|----------|
| T5201C7 | 3 inch | COB | 7 | 100-130V | 90 | 10°/20°/30° | Ra80/Ra90 | 2700-6000 | 50000 | Yes |
| T5201C7 | 4 inch | COB | 9 | 100-277V | 90 | 10°/20°/30° | Ra80/Ra90 | 2700-6000 | 50000 | Yes |
| T5201C7 | 4 inch | COB | 12-15 | 100-347V | 90 | 10°/20°/30° | Ra80/Ra90 | 2700-6000 | 50000 | Yes |

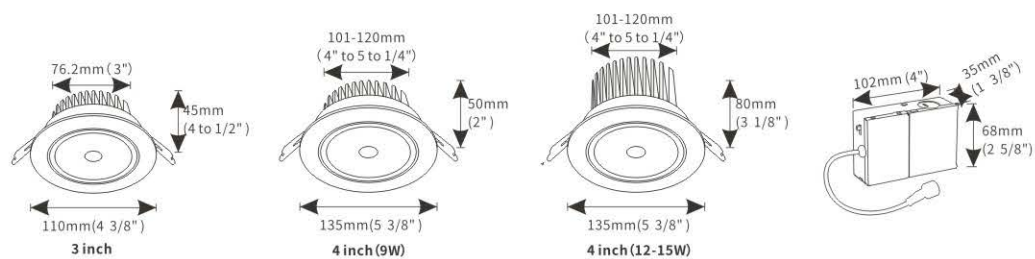

LED Downlight - T5201A7/T5201B7



| Model | Size | LED Chips | Watt(W) | Input Voltage | Efficacy lm/w | Beam Angle | CRI | Color Temp(K) | Lifespan (hrs) | Dimmable |
|---------|--------|-----------|---------|---------------|---------------|-------------|-----------|---------------|----------------|----------|
| T5201A7 | 3 inch | SMD | 7 | 100-130V | 90 | 10°/20°/30° | Ra80/Ra90 | 2700-6000 | 50000 | Yes |
| T5201A7 | 4 inch | SMD | 9 | 100-277V | 90 | 10°/20°/30° | Ra80/Ra90 | 2700-6000 | 50000 | Yes |
| T5201A7 | 4 inch | SMD | 12-15 | 100-347V | 90 | 10°/20°/30° | Ra80/Ra90 | 2700-6000 | 50000 | Yes |
| T5201B7 | 3 inch | SMD | 7 | 100-130V | 90 | 10°/20°/30° | Ra80/Ra90 | 2700-6000 | 50000 | Yes |
| T5201B7 | 4 inch | SMD | 9 | 100-277V | 90 | 10°/20°/30° | Ra80/Ra90 | 2700-6000 | 50000 | Yes |
| T5201B7 | 4 inch | SMD | 12-15 | 100-347V | 90 | 10°/20°/30° | Ra80/Ra90 | 2700-6000 | 50000 | Yes |

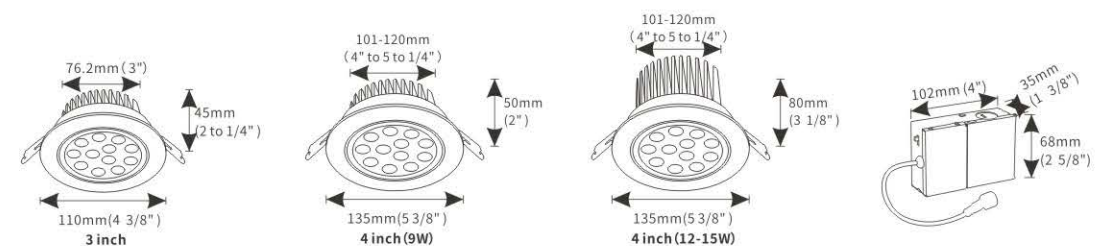

- Trim Finish: White, Black, Brush Nickel, Chrome (Aluminum Body)
- Air Tight & IC Rated
- High Efficiency
- Driver Type: Constant Current





LP-T3208

LP-T8208



| Model | Size | LED Chips | Watt(W) | Input Voltage | Efficacy lm/w | Beam Angle | CRI | Color Temp(K) | Lifespan (hrs) | Dimmable |
|----------|----------|-----------|---------|----------------------|---------------|-----------------|-----------|---------------|----------------|----------|
| LP-T3208 | 3.5 inch | COB | 6-9 | 100-130V 100-277V | 90 | 15°/24°/36°/60° | Ra80/Ra90 | 2700-6000 | 50000 | Yes |
| LP-T8208 | 4 inch | COB | 9-15 | 100-277V 100-347V | 90 | 15°/24°/36°/60° | Ra80/Ra90 | 2700-6000 | 50000 | Yes |

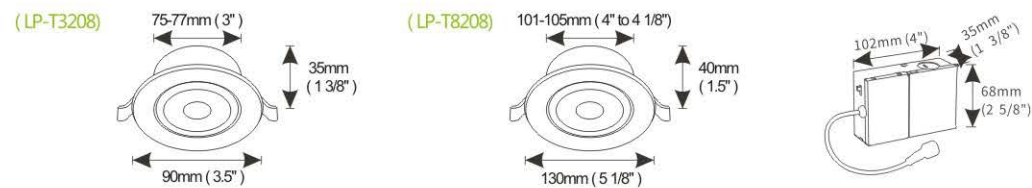

- Trim Finish: White, Black, Brush Nickel, Chrome (Aluminum Body)
- Air Tight & IC Rated
- High Efficiency
- Driver Type: Constant Current



- IC Rated Junction Box-UL Isolated Driver(Aluminum/Iron, Metal Junction Box Optional)
- 3CCT Adjusted by DIP Switch: 30K/40K/50K
- 5CCT Adjusted by DIP Switch: 27K/30K/40K/50K/60K
- 3CCT Adjusted by DIP Switch and Wall Switch Control: 30K/40K/50K
- 5CCT Adjusted by DIP Switch and Wall Switch Control: 27K/30K/35K/40K/50K



LED DOWNLIGHT WITH NIGHT LIGHT



Down light mode



Night light mode

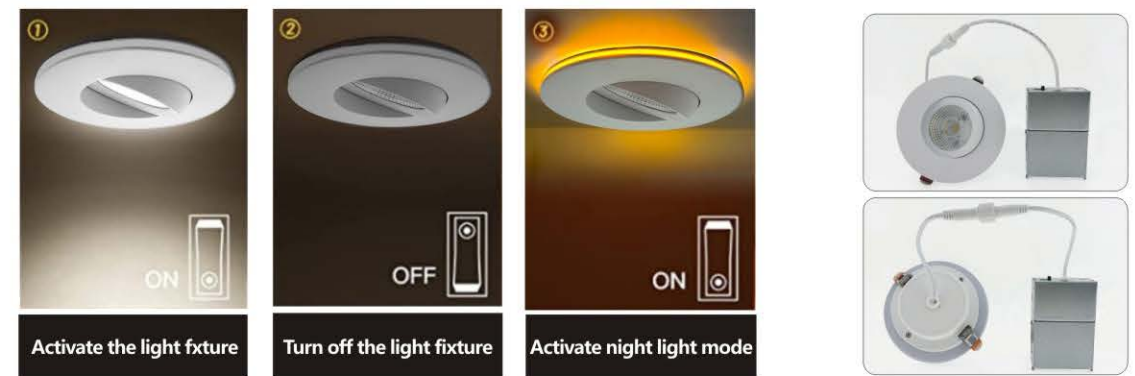
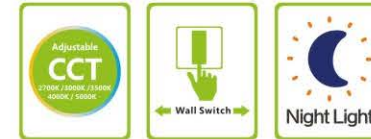

| Model | Size | LED Chips | Watt(W) | Input Voltage | Efficacy lm/w | Beam Angle | CRI | Color Temp(K) | Lifespan (hrs) | Dimmable |
|-----------|--------|-----------|---------|----------------------|---------------|-----------------|-----------|---------------|----------------|----------|
| LP-TN3208 | 3 inch | COB | 7 | 100-130V 100-277V | 90 | 15°/24°/36°/60° | Ra80/Ra90 | 2700-6000 | 50000 | Yes |
| LP-TN8208 | 4 inch | COB | 9 | 100-347V | 90 | 15°/24°/36°/60° | Ra80/Ra90 | 2700-6000 | 50000 | Yes |

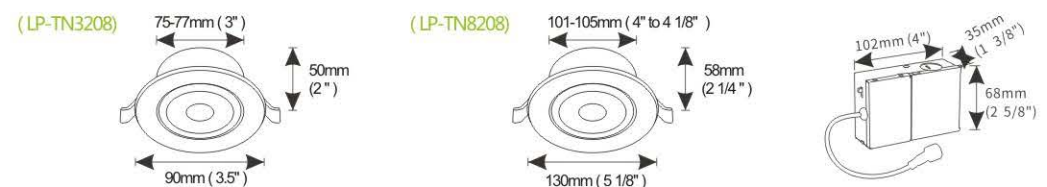

LED Downlight - MG3360-D



| Model | Size | LED Chips | Watt(W) | Input Voltage | Efficacy lm/w | Beam Angle | CRI | Color Temp(K) | Lifespan (hrs) | Dimmable |
|----------|--------|-----------|---------|---------------|---------------|-------------|-----------|---------------|----------------|----------|
| MG3360-D | 3 inch | COB | 7 | 100-130V | 90/100 | 15°/24°/36° | Ra80/Ra90 | 2700-6000 | 50000 | Yes |
| MG4360-D | 4 inch | COB | 9 | 100-277V | 90/100 | 15°/24°/36° | Ra80/Ra90 | 2700-6000 | 50000 | Yes |
| MG6360-D | 6 inch | COB | 15 | 100-347V | 90/100 | 15°/24°/36° | Ra80/Ra90 | 2700-6000 | 50000 | Yes |

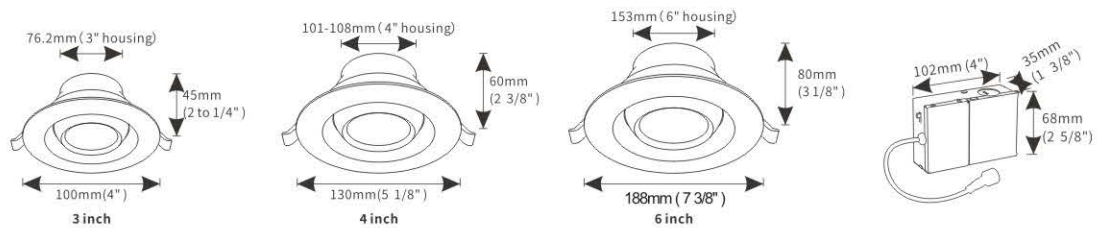

New Construction Plate
Compatible with 3" 4" 6" trims
External Driver Mounting Points



LED Downlight-MG3360-H



3" 4" 6" Retrofit Recessed Downlight Can



| Model | Size | LED Chips | Watt(W) | Input Voltage | Efficacy lm/w | Beam Angle | CRI | Color Temp(K) | Lifespan (hrs) | Dimmable |
|----------|--------|-----------|---------|---------------|---------------|-------------|-----------|---------------|----------------|----------|
| MG3360-H | 3 inch | COB | 7 | 100-130V | 90/100 | 15°/24°/36° | Ra80/Ra90 | 2700-6000 | 50000 | Yes |
| MG4360-H | 4 inch | COB | 9 | 100-277V | 90/100 | 15°/24°/36° | Ra80/Ra90 | 2700-6000 | 50000 | Yes |
| MG6360-H | 6 inch | COB | 15 | 100-347V | 90/100 | 15°/24°/36° | Ra80/Ra90 | 2700-6000 | 50000 | Yes |

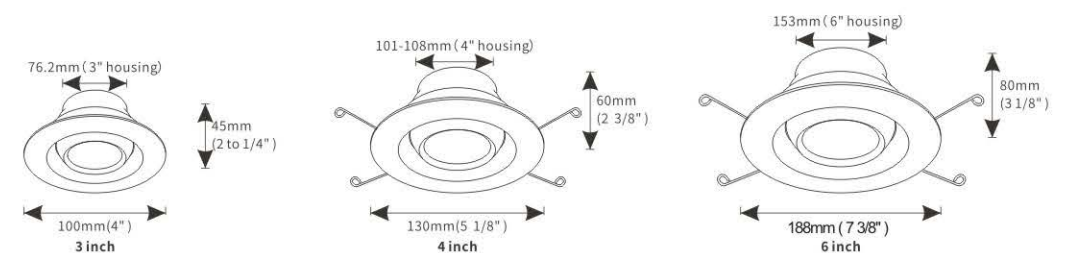

FLAT CONE AND DIRECTIONAL



| Model | LED Chips | Watt(W) | Input Voltage | Efficacy lm/w | Beam Angle | CRI | Color Temp(K) | Lifespan(hrs) | Dimmable |
|------------|-----------|---------|----------------------|---------------|-----------------|------|---------------|---------------|----------|
| LP-15C1031 | COB | 5 | | 90 | 12°/24°/38° | Ra90 | 2700-6000 | 50000 | Yes |
| LP-3C1031 | COB | 7 | | 90 | 24°/38°/50° | Ra90 | 2700-6000 | 50000 | Yes |
| LP-35C1031 | COB | 12 | 100-130V 100-277V | 90 | 15°/24°/38°/60° | Ra90 | 2700-6000 | 50000 | Yes |
| LP-45C1031 | COB | 20 | 100-347V | 90 | 15°/24°/38°/60° | Ra90 | 2700-6000 | 50000 | Yes |
| LP-55C1031 | COB | 24 | | 90 | 15°/24°/38°/60° | Ra90 | 2700-6000 | 50000 | Yes |
| LP-55C1031 | COB | 30 | | 90 | 15°/24°/38°/60° | Ra90 | 2700-6000 | 50000 | Yes |

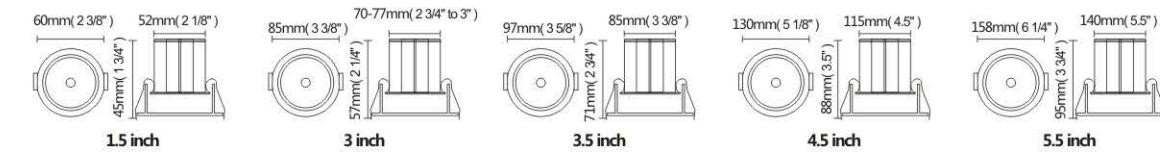

Spotlights Series

LIPAI's movable downlights can make single CCT, 3CCT and 5 CCT adjustable with isolated flicker-free metal drivers, available to Triac dimmable, 120-277/347V 0-10V dimmable. There're multiple cut out, color, shape, wattages and design available to meet your demands. Air Tight and IC Rated. Easy installation for remodel and new constructions can save some money and labour. It's a mature, flexible and widely used product series, which can deal with challenges of lighting performance criteria for high-end hospitality, residential projects and hotels etc.



DEEP CONE AND DIRECTIONAL



| Model | LED Chips | Watt(W) | Input Voltage | Efficacy lm/w | Beam Angle | CRI | Color Temp(K) | Lifespan(hrs) | Dimmable |
|-------------|-----------|---------|----------------------|---------------|-----------------|------|---------------|---------------|----------|
| LP-3C1031B | COB | 7 | | 90 | 24°/38°/50° | Ra90 | 2700-6000 | 50000 | Yes |
| LP-35C1031B | COB | 12 | 100-130V 100-277V | 90 | 15°/24°/38°/60° | Ra90 | 2700-6000 | 50000 | Yes |
| LP-35C1031B | COB | 20 | 100-347V | 90 | 15°/24°/38°/60° | Ra90 | 2700-6000 | 50000 | Yes |
| LP-5C1031B | COB | 24 | | 90 | 15°/24°/38°/60° | Ra90 | 2700-6000 | 50000 | Yes |
| LP-6C1031B | COB | 30 | | 90 | 15°/24°/38°/60° | Ra90 | 2700-6000 | 50000 | Yes |

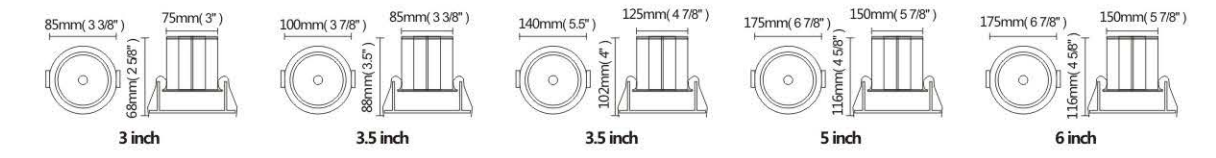

| Model | LED Chips | Watt(W) | Input Voltage | Efficacy lm/w | Beam Angle | CRI | Color Temp(K) | Lifespan(hrs) | Dimmable |
|-------------|-----------|---------|----------------------|---------------|-----------------|------|---------------|---------------|----------|
| LP-2F1031B | COB | 5 | | 90 | 12°/24°/38° | Ra90 | 2700-6000 | 50000 | Yes |
| LP-3F1031B | COB | 7 | | 90 | 24°/38°/50° | Ra90 | 2700-6000 | 50000 | Yes |
| LP-35F1031B | COB | 12 | 100-130V 100-277V | 90 | 15°/24°/38°/60° | Ra90 | 2700-6000 | 50000 | Yes |
| LP-35F1031B | COB | 20 | 100-347V | 90 | 15°/24°/38°/60° | Ra90 | 2700-6000 | 50000 | Yes |
| LP-5F1031B | COB | 24 | | 90 | 15°/24°/38°/60° | Ra90 | 2700-6000 | 50000 | Yes |
| LP-6F1031B | COB | 30 | | 90 | 15°/24°/38°/60° | Ra90 | 2700-6000 | 50000 | Yes |

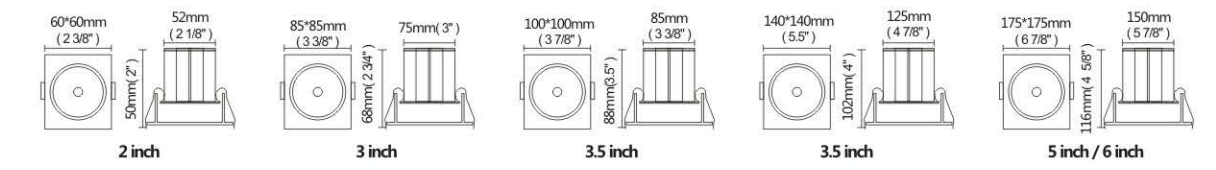



ULTRA THIN ANTI-GLARE DOWNLIGHT

- Multiple Color
- Heat Dissipation
- Multiple Beam Angle
- Anti-glare
- High-end Aluminum
- Multiple Lens



| Model | LED Chips | Watt(W) | Input Voltage | Efficacy lm/w | Beam Angle | CRI | Color Temp(K) | Lifespan(hrs) | Dimmable |
|-----------|-----------|---------|---------------|---------------|-----------------|------|---------------|---------------|----------|
| LP-3C1034 | COB | 9-12 | 100-130V | 90 | 15°/24°/36°/50° | Ra90 | 2700-6000 | 50000 | Yes |
| LP-4C1034 | COB | 12-15 | 100-277V | 90 | 15°/24°/36°/50° | Ra90 | 2700-6000 | 50000 | Yes |
| LP-5C1034 | COB | 18-24 | 100-347V | 90 | 15°/24°/36°/50° | Ra90 | 2700-6000 | 50000 | Yes |

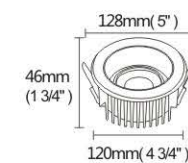
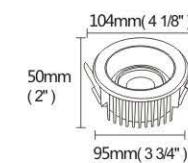
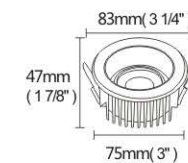

Optical Reflector





Aluminum, good heat dissipation, longer lifespan



| Model | Size | LED Chips | Watt(W) | Input Voltage | Efficacy lm/w | Beam Angle | CRI | Color Temp(K) | Lifespan(hrs) | Dimmable |
|-----------|-------|-----------|---------|----------------------|---------------|-----------------|-----------|---------------|---------------|----------|
| LP-3C1035 | 3inch | COB | 12/15 | 100-130V 100-277V | 90 | 15°/24°/36°/45° | Ra80/Ra90 | 2700-6000 | 50000 | Yes |
| LP-4C1035 | 4inch | COB | 15/20 | 100-347V | 90 | 15°/24°/36°/45° | Ra80/Ra90 | 2700-6000 | 50000 | Yes |

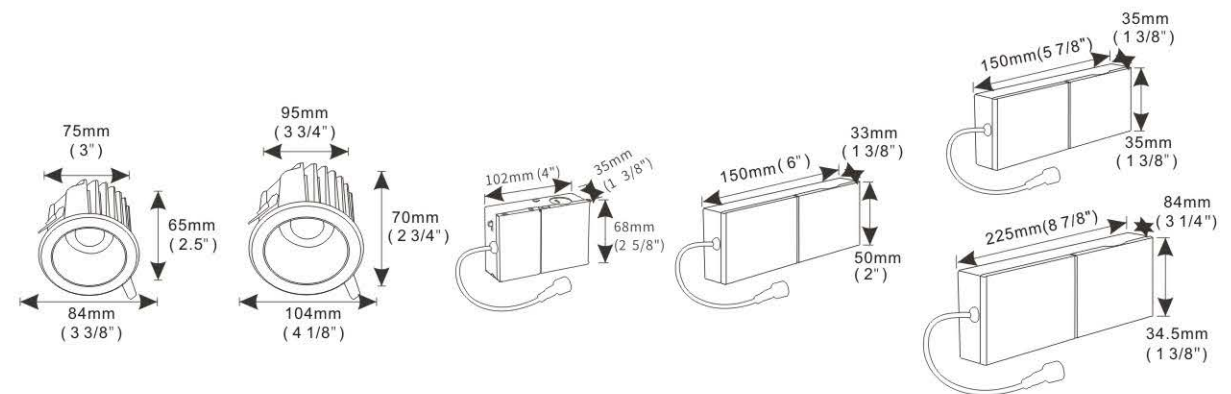

Optical Reflector



EMBEDDED ANTI-GLARE LAMP

ONE DIE CASTING ALUMINUM DESIGN
MEET DIFFERENT NEEDS

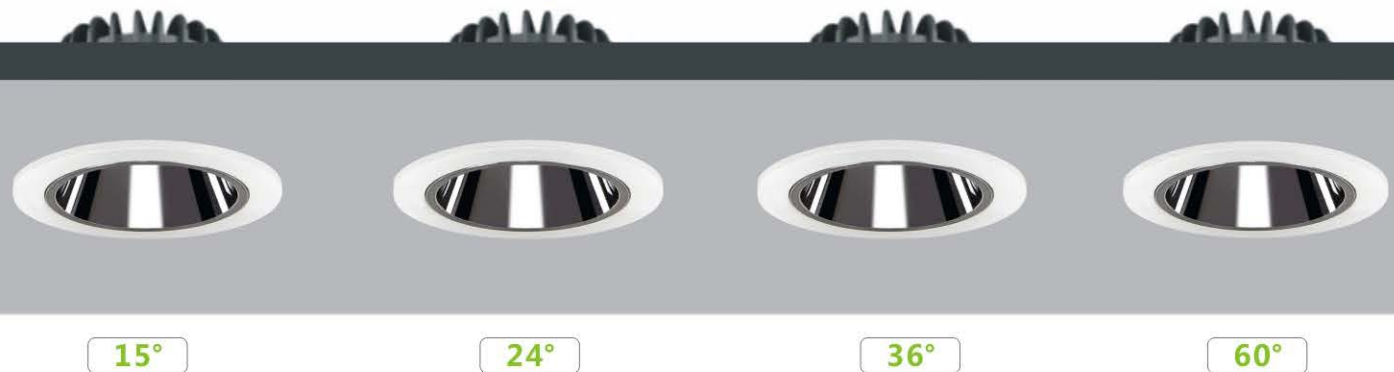



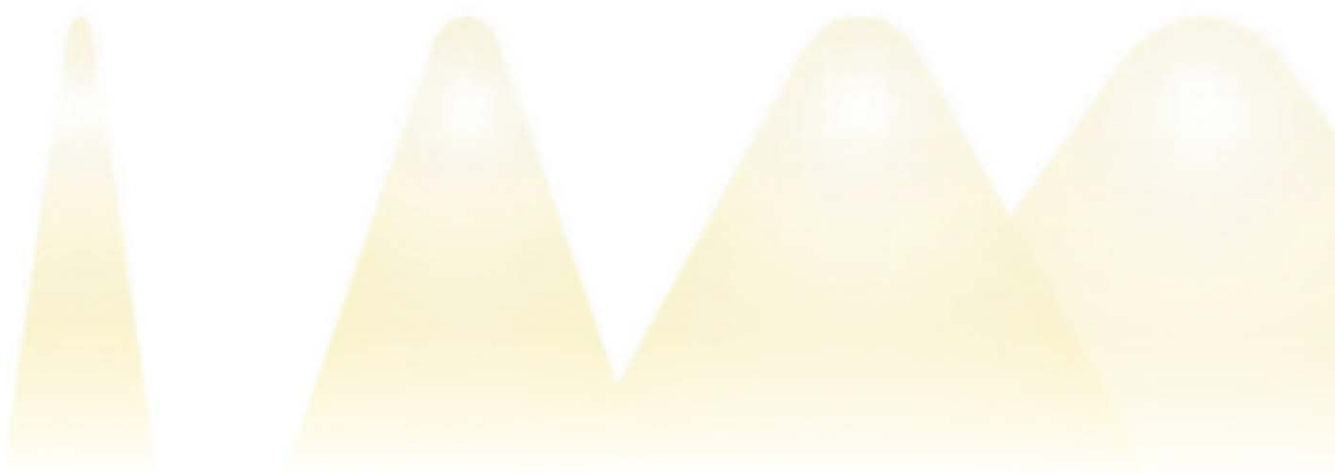

15° 24° 36° 60°

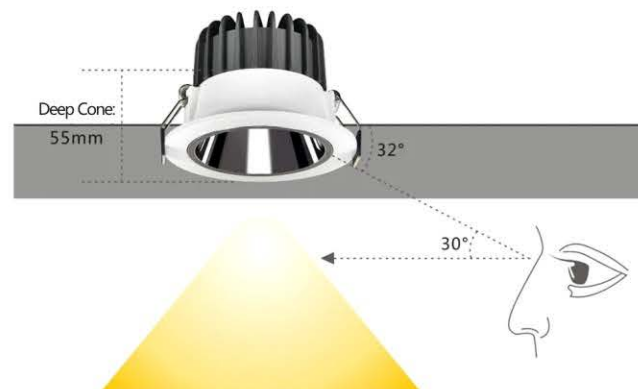
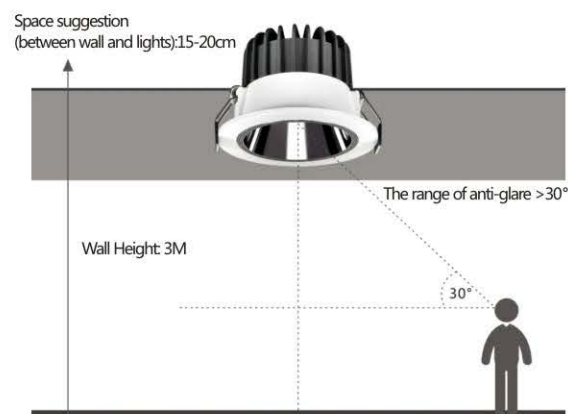

Space suggestion
(between wall and lights): 15-20cm



- 
Anti Dazzle
- 
High Color Rendering
- 
Multiple Sizes
- 
Multiple Color Temperature



| Model | Size | LED Chips | Watt(W) | Input Voltage | Efficacy lm/w | Beam Angle | CRI | Color Temp(K) | Lifespan(hrs) | Dimmable |
|-----------|-------|-----------|---------|----------------------|---------------|-----------------|-----------|---------------|---------------|----------|
| LP-3C1036 | 3inch | COB | 12 | | 90 | 15°/24°/36°/60° | Ra80/Ra90 | 2700-6000 | 50000 | Yes |
| LP-4C1036 | 4inch | COB | 15 | 100-130V 100-277V | 90 | 15°/24°/36°/60° | Ra80/Ra90 | 2700-6000 | 50000 | Yes |
| LP-5C1036 | 3inch | COB | 24 | 100-347V | 90 | 15°/24°/36°/60° | Ra80/Ra90 | 2700-6000 | 50000 | Yes |
| LP-6C1036 | 4inch | COB | 36 | | 90 | 15°/24°/36°/60° | Ra80/Ra90 | 2700-6000 | 50000 | Yes |

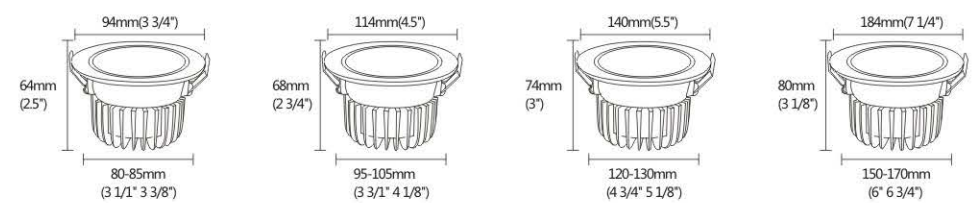

Optical Reflector



1" 3" 4" 6" 8" TRIM CHANGEABLE LED DOWNLIGHT



**INTERCHANGEABLE TRIMS
ROUND OR SQUARE**

- Adjustable -

LP-2B1037



- Fixed -

LP-2C1037

- Anti-Glare Adjustable -

LP-2B1037-A



| Model | Size(mm) | Cut out(mm) | LED Chips | Watt(W) | Input Voltage | Efficacy lm/w | Beam Angle | CRI | Color Temp(K) | Lifespan(hrs) | Dimmable |
|------------|-----------|-------------|-----------|---------|----------------------|---------------|-----------------|-----------|---------------|---------------|----------|
| LP-2C1037 | 64*H73 | 55 | COB | 7 | | 90 | 13°/24°/38°/60° | Ra80/Ra90 | 2700-6000 | 50000 | Yes |
| LP-3C1037 | 85*H91 | 80 | COB | 12 | 100-130V 100-277V | 90 | 13°/24°/38°/60° | Ra80/Ra90 | 2700-6000 | 50000 | Yes |
| LP-4C1037 | 105*H120 | 95 | COB | 20 | 100-347V | 90 | 13°/24°/38°/60° | Ra80/Ra90 | 2700-6000 | 50000 | Yes |
| LP-4FC1037 | 85*85*H91 | 80*80 | COB | 12 | | 90 | 13°/24°/38°/60° | Ra80/Ra90 | 2700-6000 | 50000 | Yes |



| Model | Size(mm) | Cut out(mm) | LED Chips | Watt(W) | Input Voltage | Efficacy lm/w | Beam Angle | CRI | Color Temp(K) | Lifespan(hrs) | Dimmable |
|------------|------------|-------------|-----------|---------|----------------------|---------------|-----------------|-----------|---------------|---------------|----------|
| LP-2B1037 | 64*H74 | 55 | COB | 7 | | 90 | 13°/24°/38°/60° | Ra80/Ra90 | 2700-6000 | 50000 | Yes |
| LP-3B1037 | 85*H89 | 80 | COB | 12 | | 90 | 13°/24°/38°/60° | Ra80/Ra90 | 2700-6000 | 50000 | Yes |
| LP-4B1037 | 105*H123 | 95 | COB | 20 | 100-130V 100-277V | 90 | 13°/24°/38°/60° | Ra80/Ra90 | 2700-6000 | 50000 | Yes |
| LP-3BF1037 | 85*85*H93 | 80*80 | COB | 12 | 100-347V | 90 | 13°/24°/38°/60° | Ra80/Ra90 | 2700-6000 | 50000 | Yes |
| LP-6F1037 | 157*55*H93 | 150*80 | COB | 2*12 | | 90 | 13°/24°/38°/60° | Ra80/Ra90 | 2700-6000 | 50000 | Yes |
| LP-8F1037 | 230*85*H93 | 220*80 | COB | 3*12 | | 90 | 13°/24°/38°/60° | Ra80/Ra90 | 2700-6000 | 50000 | Yes |





1" 3" 4" LED TRIMLESS DOWN LIGHT

Lipai Trimless Downlight Suitable To Residential Settings, Available To Multiple Color Reflector With A Mud-in Trimless Look.



| Model | Size | LED Chips | Watt(W) | Input Voltage | Efficacy lm/w | Beam Angle | CRI | Color Temp(K) | Lifespan(hrs) | Dimmable |
|-----------|-------|-----------|---------|----------------------------------|---------------|-------------|------|---------------|---------------|----------|
| LP-2C1038 | 2inch | COB | 8 | 100-130V 100-277V 100-347V | 90/100 | 15°/24°/36° | Ra90 | 2700-6000 | 50000 | Yes |
| LP-3C1038 | 3inch | COB | 8 | | 90/100 | 15°/24°/36° | Ra90 | 2700-6000 | 50000 | Yes |
| LP-3C1038 | 3inch | COB | 12 | | 90/100 | 15°/24°/36° | Ra90 | 2700-6000 | 50000 | Yes |
| LP-3C1038 | 3inch | COB | 15 | | 90/100 | 15°/24°/36° | Ra90 | 2700-6000 | 50000 | Yes |
| LP-4C1038 | 4inch | COB | 20 | | 90/100 | 15°/24°/36° | Ra90 | 2700-6000 | 50000 | Yes |

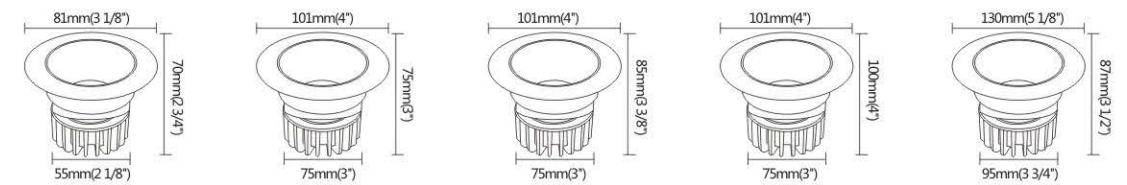



IP65
Waterproof

1" 2" 3" 4" 5" LED IP65 WATERPROOF DOWNLIGHT

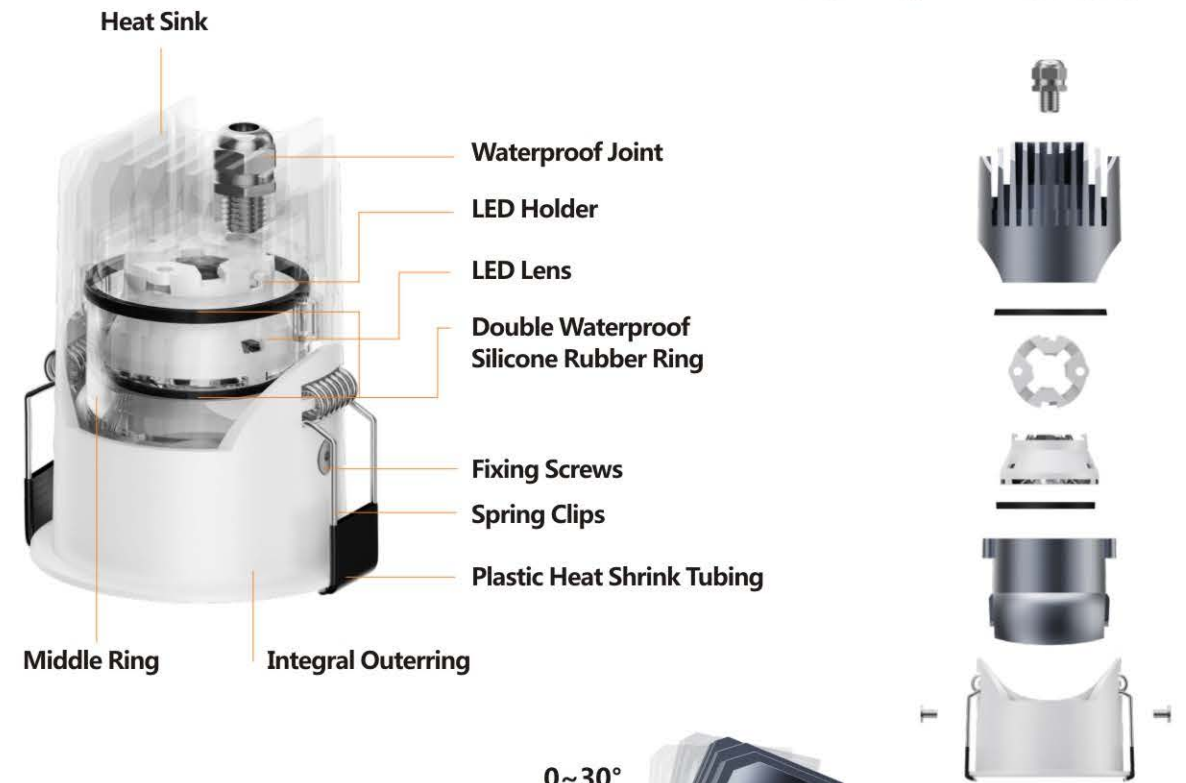

| Model | LED Chips | Watt(W) | Input Voltage | Efficacy lm/w | Beam Angle | CRI | Color Temp(K) | Lifespan(hrs) | Dimmable |
|------------|-----------|---------|---------------|---------------|---------------------|------|---------------|---------------|----------|
| LP-15C1039 | COB | 7 | | 90/100 | 10°/15°/24°/36°/55° | Ra90 | 2700-6000 | 50000 | Yes |
| LP-24C1039 | COB | 7 | | 90/100 | 10°/15°/24°/36°/55° | Ra90 | 2700-6000 | 50000 | Yes |
| LP-2C1039 | COB | 9 | 100-130V | 90/100 | 10°/15°/24°/36°/55° | Ra90 | 2700-6000 | 50000 | Yes |
| LP-35C1039 | COB | 12 | 100-277V | 90/100 | 10°/15°/24°/36°/55° | Ra90 | 2700-6000 | 50000 | Yes |
| LP-3C1039 | COB | 15 | 100-347V | 90/100 | 10°/15°/24°/36°/55° | Ra90 | 2700-6000 | 50000 | Yes |
| LP-4C1039 | COB | 28 | | 90/100 | 15°/24°/36°/55° | Ra90 | 2700-6000 | 50000 | Yes |
| LP-5C1039 | COB | 35 | | 90/100 | 15°/24°/36°/55° | Ra90 | 2700-6000 | 50000 | Yes |

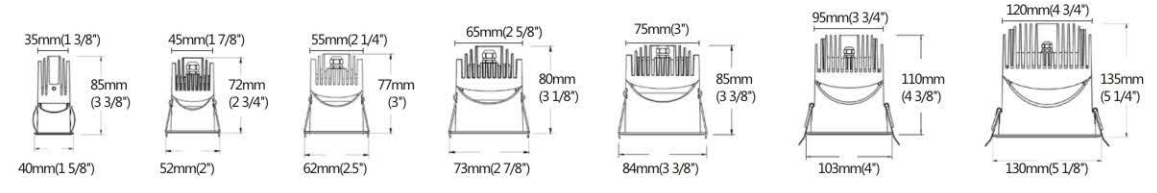



1" 3" 3.5" 4" 5" HIGH QUALITY IP65 WATERPROOF LED DOWNLIGHT



10° 15° 24° 36° 50°

Optional Angle

Multiple Beam Angles Can Be Selected To Meet Different Lighting Space Requirements

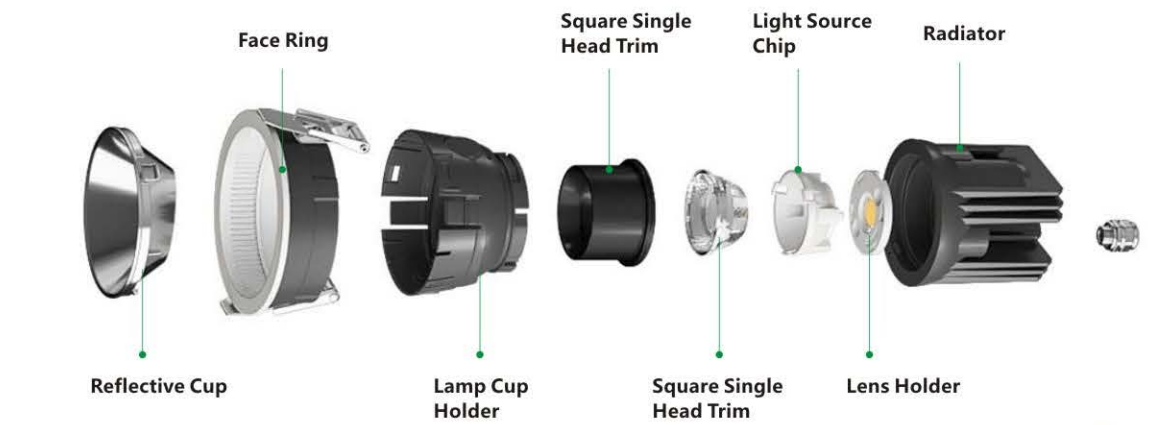

INTERCHANGEABLE TRIMS ROUND OR SQUARE



Trim



Reflectors



Optical Accessories

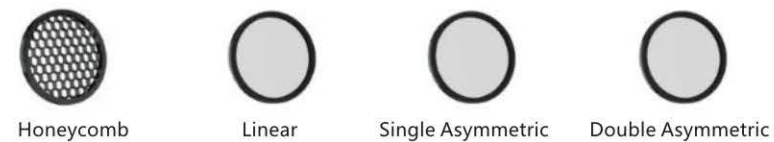

Filters Effect



The Effect Of Different Angle With Different Filters



24° Lighting Focusing 24° Lighting Flooding 24° Lighting Unilateral 24° Lighting Bilateral

LED Downlight -LP-1C1042



1" 3" 3.5" 4" 5" HIGH QUALITY IP65 WATERPROOF LED DOWNLIGHT



LP-1C1042



LP-1C1042-A



LED Downlight -LP-1C1042



| Model | Size(mm) | Cut out(mm) | Watt(W) | Input Voltage | LED Chips | Efficacy lm/w | Beam Angle | CRI | Color Temp(K) | Lifespan(hrs) | Dimmable |
|-------------|----------|-------------|---------|----------------------------------|-----------|---------------|-----------------|------|---------------|---------------|----------|
| LP-1C1042 | 65*H95 | 55 | 9-12 | 100-130V 100-277V 100-347V | COB | 90/100 | 15°/24°/36°/55° | Ra90 | 2700-6000 | 50000 | Yes |
| LP-2C1042 | 82*H99 | 75 | 12-15 | | COB | 90/100 | 15°/24°/36°/55° | Ra90 | 2700-6000 | 50000 | Yes |
| LP-4C1042 | 105*H113 | 95 | 25-28 | 100-130V 100-277V 100-347V | COB | 90/100 | 15°/24°/36°/55° | Ra90 | 2700-6000 | 50000 | Yes |
| LP-1C1042-A | 88*H95 | 95 | 9-12 | | COB | 90/100 | 15°/24°/36°/55° | Ra90 | 2700-6000 | 50000 | Yes |
| LP-2C1042-A | 108*H99 | 115 | 12-15 | 100-130V 100-277V 100-347V | COB | 90/100 | 15°/24°/36°/55° | Ra90 | 2700-6000 | 50000 | Yes |
| LP-4C1042-A | 128*H113 | 145 | 25-28 | | COB | 90/100 | 15°/24°/36°/55° | Ra90 | 2700-6000 | 50000 | Yes |

LP-1C1042-C



LP-1C1042-D



| Model | Size(mm) | Cut out(mm) | Watt(W) | Input Voltage | LED Chips | Efficacy lm/w | Beam Angle | CRI | Color Temp(K) | Lifespan(hrs) | Dimmable |
|-------------|--------------|-------------|---------|----------------------------------|-----------|---------------|-----------------|------|---------------|---------------|----------|
| LP-1C1042-C | 65*65*H101 | 58*55 | 9-12 | 100-130V 100-277V 100-347V | COB | 90/100 | 15°/24°/36°/55° | Ra90 | 2700-6000 | 50000 | Yes |
| LP-3C1042-C | 85*85*H109 | 78*75 | 12-15 | | COB | 90/100 | 15°/24°/36°/55° | Ra90 | 2700-6000 | 50000 | Yes |
| LP-4C1042-C | 105*105*H126 | 98*95 | 25-28 | 100-130V 100-277V 100-347V | COB | 90/100 | 15°/24°/36°/55° | Ra90 | 2700-6000 | 50000 | Yes |
| LP-1C1042-D | 112*65*H101 | 58*55 | 9-12 | | COB | 90/100 | 15°/24°/36°/55° | Ra90 | 2700-6000 | 50000 | Yes |
| LP-3C1042-D | 146*75*H109 | 78*75 | 12-15 | 100-130V 100-277V 100-347V | COB | 90/100 | 15°/24°/36°/55° | Ra90 | 2700-6000 | 50000 | Yes |
| LP-4C1042-D | 166*105*H126 | 98*95 | 25-28 | | COB | 90/100 | 15°/24°/36°/55° | Ra90 | 2700-6000 | 50000 | Yes |

LP-1C1042-E



LP-1C1042-F



| Model | Size(mm) | Cut out(mm) | Watt(W) | Input Voltage | LED Chips | Efficacy lm/w | Beam Angle | CRI | Color Temp(K) | Lifespan(hrs) | Dimmable |
|-------------|--------------|-------------|---------|----------------------------------|-----------|---------------|-----------------|------|---------------|---------------|----------|
| LP-1C1042-E | 115*65*H101 | 105*58 | 9-12 | 100-130V 100-277V 100-347V | COB | 90/100 | 15°/24°/36°/55° | Ra90 | 2700-6000 | 50000 | Yes |
| LP-3C1042-E | 115*75*H109 | 145*78 | 12-15 | | COB | 90/100 | 15°/24°/36°/55° | Ra90 | 2700-6000 | 50000 | Yes |
| LP-4C1042-E | 196*105*H126 | 185*98 | 25-28 | 100-130V 100-277V 100-347V | COB | 90/100 | 15°/24°/36°/55° | Ra90 | 2700-6000 | 50000 | Yes |
| LP-1C1042-F | 175*65*H101 | 110*55 | 9-12 | | COB | 90/100 | 15°/24°/36°/55° | Ra90 | 2700-6000 | 50000 | Yes |
| LP-2C1042-F | 216*75*H109 | 150*75 | 12-15 | 100-130V 100-277V 100-347V | COB | 90/100 | 15°/24°/36°/55° | Ra90 | 2700-6000 | 50000 | Yes |
| LP-4C1042-F | 256*105*H126 | 190*95 | 25-28 | | COB | 90/100 | 15°/24°/36°/55° | Ra90 | 2700-6000 | 50000 | Yes |

2" 3" 3.5" HIGH QUALITY LED DOWNLIGHTS SPOTLIGHTS SERIES

LIPAI's movable downlights can make single CCT, 3CCT and 5CCT adjustable with isolated flicker-free metal drivers, available to Triac dimmable, 120-277/347V 0-10V dimmable. There're multiple cut out, color, shape, wattages and design available to meet your demands. Air Tight and IC Rated. Easy installation for remodel and new constructions can save some money and labour. It's a mature, flexible and widely used product series, which can deal with challenges of lighting performance criteria for high-end hospitality, residential projects and hotels etc.

Space Suggestion (Between Wall And Lights): 15-20cm

Anti-glare Design

The Refractive Materials And Deep Cone Can Prevent Dazzle



The range of anti-glare >30°



Aluminum, Good Heat Dissipation, Longer Lifespan

| Model | Size | LED Chips | Watt(W) | Input Voltage | Efficacy lm/w | Beam Angle | CRI | Color Temp(K) | Lifespan(hrs) | Dimmable |
|-----------|---------|-----------|---------|----------------------|---------------|-----------------|------|---------------|---------------|----------|
| LP-2C1043 | 2inch | COB | 8 | | 90/100 | 15°/24°/36°/60° | Ra90 | 2700-6000 | 50000 | Yes |
| LP-3C1043 | 3inch | COB | 12 | 100-130V 100-277V | 90/100 | 15°/24°/36°/60° | Ra90 | 2700-6000 | 50000 | Yes |
| LP-3C1043 | 3inch | COB | 15 | 100-347V | 90/100 | 15°/24°/36°/60° | Ra90 | 2700-6000 | 50000 | Yes |
| LP-4C1043 | 3.5inch | COB | 20 | | 90/100 | 15°/24°/36°/60° | Ra90 | 2700-6000 | 50000 | Yes |

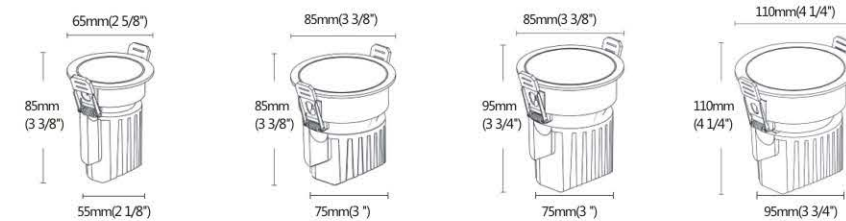

Optical Reflector



Matt White Matt Black Shiny Black Shiny Silver Rose Golden Round Oval



| Model | Size | LED Chips | Watt(W) | Input Voltage | Efficacy lm/w | Beam Angle | CRI | Color Temp(K) | Lifespan(hrs) | Dimmable |
|------------|-------|-----------|---------|----------------------|---------------|-----------------|------|---------------|---------------|----------|
| LP-3F1043 | 3inch | COB | 12 | | 90/100 | 15°/24°/36°/60° | Ra90 | 2700-6000 | 50000 | Yes |
| LP-3F1043 | 3inch | COB | 15 | | 90/100 | 15°/24°/36°/60° | Ra90 | 2700-6000 | 50000 | Yes |
| LP-4F1043 | 4inch | COB | 20 | 100-130V 100-277V | 90/100 | 15°/24°/36°/60° | Ra90 | 2700-6000 | 50000 | Yes |
| LP-3F1043B | 3inch | COB | 2*12 | 100-347V | 90/100 | 15°/24°/36°/60° | Ra90 | 2700-6000 | 50000 | Yes |
| LP-3F1043B | 3inch | COB | 2*15 | | 90/100 | 15°/24°/36°/60° | Ra90 | 2700-6000 | 50000 | Yes |
| LP-4F1043B | 4inch | COB | 2*20 | | 90/100 | 15°/24°/36°/60° | Ra90 | 2700-6000 | 50000 | Yes |

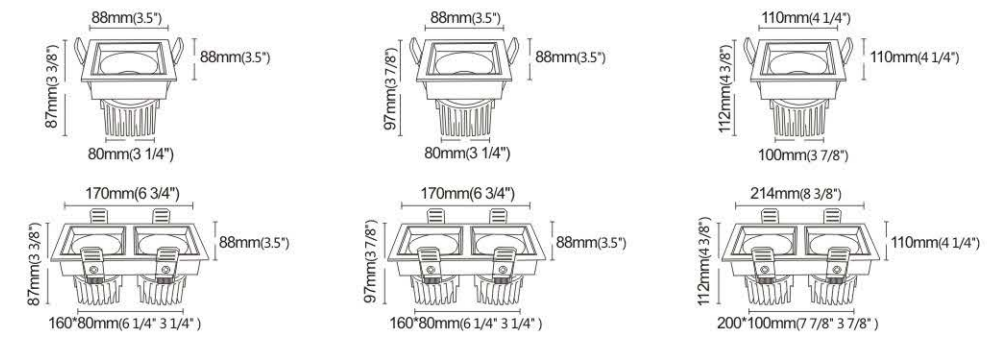

Optical Reflector



1" 2" 3" 3.5" 4" 5" 7" 8" MINI COB LED DOWNLIGHT SERIES (HIGH LUMEN)



High Lumens LED
High CRI 90



Strong Stainless Clip & Plastic Tip
Easy to Install



Aluminum, Good Heat Dissipation ,Longer Lifespan

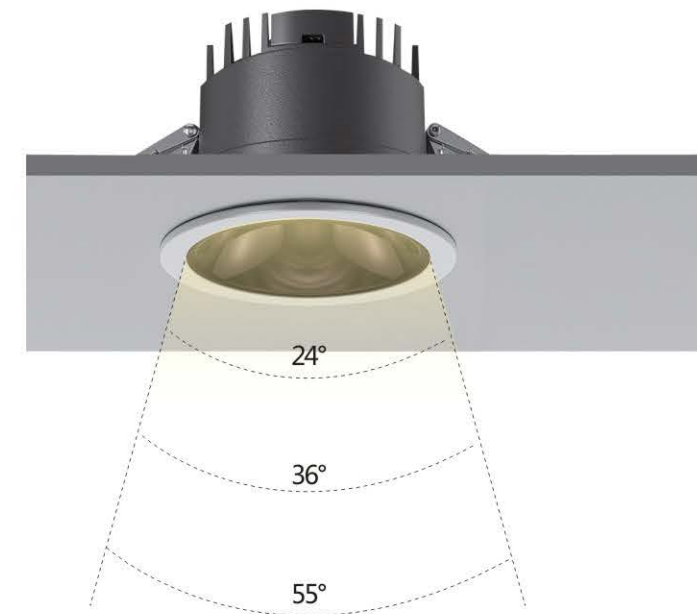

| Model | Size | LED Chips | Watt(W) | Input Voltage | Efficacy lm/w | Beam Angle | CRI | Color Temp(K) | Lifespan(hrs) | Dimmable |
|------------|---------|-----------|---------|----------------------|---------------|-------------|------|---------------|---------------|----------|
| LP-15C1047 | 1inch | COB | 7 | | 90/100 | 24°/36°/55° | Ra90 | 2700-6000 | 50000 | Yes |
| LP-2C1047 | 2inch | COB | 10 | | 90/100 | 24°/36°/55° | Ra90 | 2700-6000 | 50000 | Yes |
| LP-25C1047 | 3inch | COB | 12 | | 90/100 | 24°/36°/55° | Ra90 | 2700-6000 | 50000 | Yes |
| LP-35C1047 | 3.5inch | COB | 15/18 | 100-130V 100-277V | 90/100 | 24°/36°/55° | Ra90 | 2700-6000 | 50000 | Yes |
| LP-4C1047 | 4inch | COB | 22 | 100-347V | 90/100 | 24°/36°/55° | Ra90 | 2700-6000 | 50000 | Yes |
| LP-5C1047 | 5inch | COB | 35 | | 90/100 | 24°/36°/55° | Ra90 | 2700-6000 | 50000 | Yes |
| LP-6C1047 | 7inch | COB | 45 | | 90/100 | 24°/36°/55° | Ra90 | 2700-6000 | 50000 | Yes |
| LP-8C1047 | 8inch | COB | 55 | | 90/100 | 24°/36°/55° | Ra90 | 2700-6000 | 50000 | Yes |

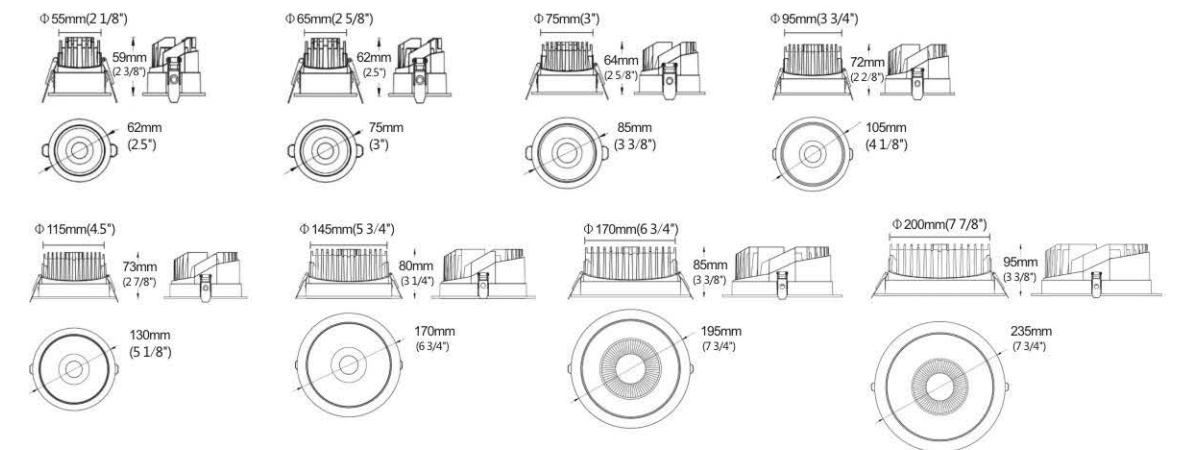

5CCT Switch Selection



Optical Reflector





HIGH POWER LED DOWNLIGHT



| Model | Size(mm) | Cut out(mm) | LED Chips | Watt(W) | Input Voltage | Efficacy lm/w | Beam Angle | CRI | Color Temp(K) | Lifespan(hrs) | Dimmable |
|-----------|----------|-------------|-----------|---------|----------------------------------|---------------|---------------|-----------|---------------|---------------|----------|
| LP-DC5202 | 75*H40 | 55-65 | SMD | 7 | 100-130V 100-277V 100-347V | 90 | 90°/100°/110° | Ra80/Ra90 | 2700-6000 | 50000 | Yes |
| LP-DC5203 | 100*H43 | 75-90 | SMD | 9 | | 90 | 90°/100°/110° | Ra80/Ra90 | 2700-6000 | 50000 | Yes |
| LP-DC5204 | 120*H43 | 90-110 | SMD | 12 | | 90 | 90°/100°/110° | Ra80/Ra90 | 2700-6000 | 50000 | Yes |
| LP-DC5205 | 150*H45 | 120-140 | SMD | 15 | | 90 | 90°/100°/110° | Ra80/Ra90 | 2700-6000 | 50000 | Yes |
| LP-DC5206 | 175*H50 | 140-165 | SMD | 18 | | 90 | 90°/100°/110° | Ra80/Ra90 | 2700-6000 | 50000 | Yes |
| LP-DC5207 | 197*H50 | 160-185 | SMD | 24 | | 90 | 90°/100°/110° | Ra80/Ra90 | 2700-6000 | 50000 | Yes |
| LP-DC5208 | 230*H55 | 190-220 | SMD | 36 | | 90 | 90°/100°/110° | Ra80/Ra90 | 2700-6000 | 50000 | Yes |

Optical Reflector

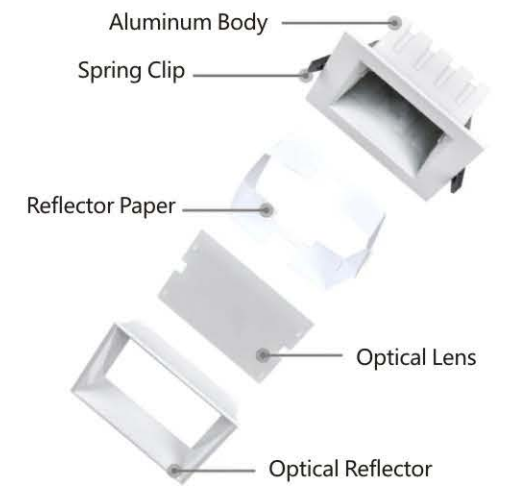

| Model | Size(mm) | Cut out(mm) | LED Chips | Watt(W) | Input Voltage | Efficacy lm/w | Beam Angle | CRI | Color Temp(K) | Lifespan(hrs) | Dimmable |
|-----------|-------------|-------------|-----------|---------|----------------------------------|---------------|---------------|-----------|---------------|---------------|----------|
| LP-DF5203 | 100*100*H44 | 75*75 | SMD | 9 | 100-130V 100-277V 100-347V | 90 | 90°/100°/110° | Ra80/Ra90 | 2700-6000 | 50000 | Yes |
| LP-DF5236 | 100*183*H43 | 75*160 | SMD | 2*9 | | 90 | 90°/100°/110° | Ra80/Ra90 | 2700-6000 | 50000 | Yes |
| LP-DF5204 | 120*120*H44 | 90*90 | SMD | 12 | | 90 | 90°/100°/110° | Ra80/Ra90 | 2700-6000 | 50000 | Yes |
| LP-DF5248 | 120*220*H43 | 90*195 | SMD | 2*12 | | 90 | 90°/100°/110° | Ra80/Ra90 | 2700-6000 | 50000 | Yes |
| LP-DF5205 | 150*150*H45 | 120*120 | SMD | 15 | | 90 | 90°/100°/110° | Ra80/Ra90 | 2700-6000 | 50000 | Yes |
| LP-DF5255 | 175*175*H50 | 140*140 | SMD | 18 | | 90 | 90°/100°/110° | Ra80/Ra90 | 2700-6000 | 50000 | Yes |
| LP-DF5206 | 197*197*H50 | 160*160 | SMD | 24 | | 90 | 90°/100°/110° | Ra80/Ra90 | 2700-6000 | 50000 | Yes |
| LP-DF5208 | 230*230*H55 | 190*190 | SMD | 36 | | 90 | 90°/100°/110° | Ra80/Ra90 | 2700-6000 | 50000 | Yes |

Optical Reflector





| Model | Size | LED Chips | Watt(W) | Input Voltage | Efficacy lm/w | Beam Angle | CRI | Color Temp(K) | Lifespan(hrs) | Dimmable |
|-------|--------|-----------|---------|----------------------|---------------|------------|-----------|---------------|---------------|----------|
| GCTD4 | 4 inch | SMD | 10-20 | 100-130V | 90/100 | 60° | Ra80/Ra90 | 2700-6000 | 50000 | Yes |
| GCTD6 | 6 inch | SMD | 20-40 | 100-277V 100-347V | 90/100 | 60° | Ra80/Ra90 | 2700-6000 | 50000 | Yes |
| GCTD8 | 8 inch | SMD | 40-60 | | 90/100 | 60° | Ra80/Ra90 | 2700-6000 | 50000 | Yes |

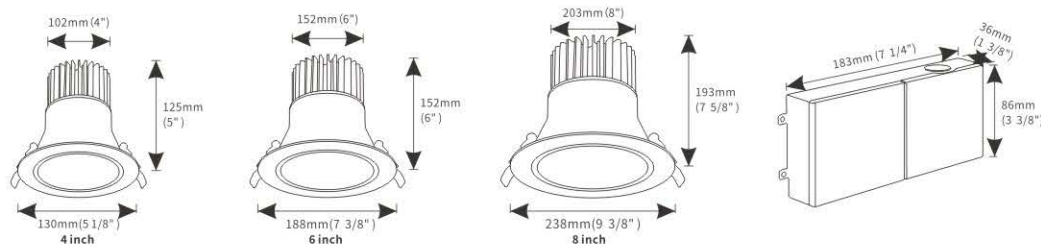

- Trim Finish: White, Black, Brush Nickel, Chrome (Aluminum Body)
- Air Tight & IC Rated
- High Efficiency
- Driver Type: Constant Current



SMART EMERGENCY BATTERY BACKUP DOWN LIGHT



| Model | Trim Size | LED Chips | Watt(W) | Input Voltage | Efficacy lm/w | Beam Angle | CRI | Color Temp(K) | Lifespan(hrs) | Dimmable |
|-----------------|-----------|-----------|---------|----------------------|---------------|------------|-----------|---------------|---------------|----------|
| E2-DL4-24W EBBU | 4 inch | SMD | 10-20 | 100-130V | 90/100 | 60° | Ra80/Ra90 | 2700-6000 | 50000 | Yes |
| E2-DL6-40W EBBU | 6 inch | SMD | 20-40 | 100-277V 100-347V | 90/100 | 60° | Ra80/Ra90 | 2700-6000 | 50000 | Yes |
| E2-DL8-40W EBBU | 8 inch | SMD | 40-60 | | 90/100 | 60° | Ra80/Ra90 | 2700-6000 | 50000 | Yes |

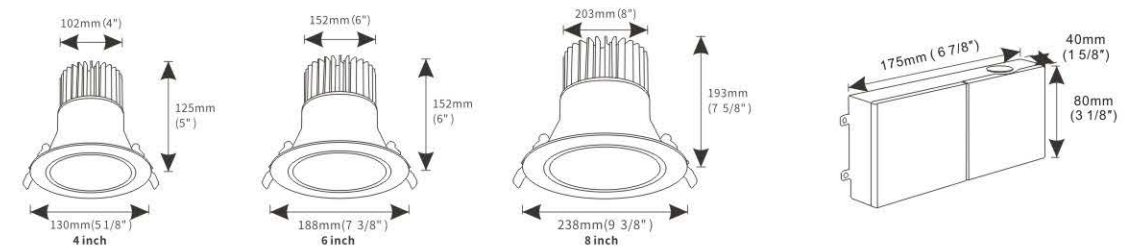

- Trim Finish: White, Black, Brush Nickel, Chrome (Aluminum Body)
- Air Tight & IC Rated
- High Efficiency
- Driver Type: Constant Current





Switch between three color temperature modes



SNAP-ON TRIM LED COMMERCIAL DOWNLIGHT



One module can compatible with 3 different trims

SWITCHABLE REFLECTORS



Switch between three color temperature modes

| Model | Size | LED Chips | Watt(W) | Input Voltage | Efficacy lm/w | Beam Angle | CRI | Color Temp(K) | Lifespan(hrs) | Dimmable |
|---------|--------|-----------|---------|----------------------------------|---------------|------------|-----------|---------------|---------------|----------|
| GCTD4-A | 4 inch | SMD | 10-20 | 100-130V 100-277V 100-347V | 90/100 | 60° | Ra80/Ra90 | 2700-6000 | 50000 | Yes |
| GCTD6-A | 6 inch | SMD | 20-40 | | 90/100 | 60° | Ra80/Ra90 | 2700-6000 | 50000 | Yes |

| Model | Trim Size | LED Chips | Watt(W) | Input Voltage | Efficacy lm/w | Beam Angle | CRI | Color Temp(K) | Lifespan(hrs) | Dimmable |
|-------|-----------|-----------|----------|----------------------------------|---------------|------------|-----------|---------------|---------------|----------|
| GCTD | 6 inch | SMD | 30/40/55 | 100-130V 100-277V 100-347V | 90/100 | 60°-80° | Ra80/Ra90 | 2700-6000 | 50000 | Yes |
| GCTD | 8 inch | SMD | 30/40/55 | | 90/100 | 60°-80° | Ra80/Ra90 | 2700-6000 | 50000 | Yes |
| GCTD | 10 inch | SMD | 30/40/55 | | 90/100 | 60°-80° | Ra80/Ra90 | 2700-6000 | 50000 | Yes |

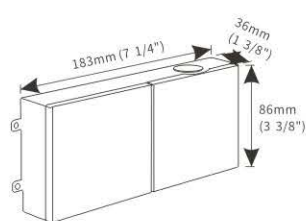
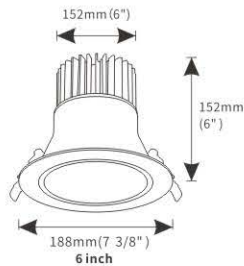
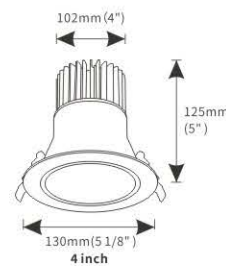

- Trim Finish: White, Black, Brush Nickel, Chrome (Aluminum Body)
- Air Tight & IC Rated
- High Efficiency
- Driver Type: Constant Current

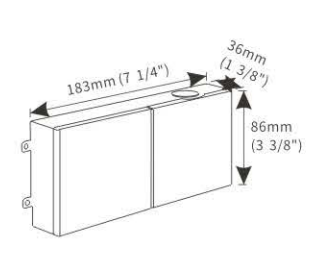
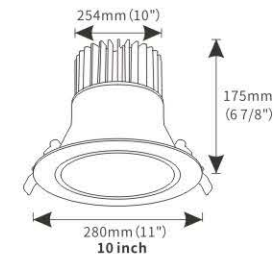
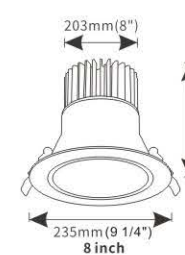
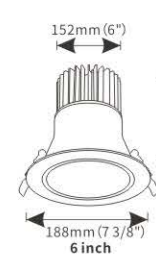

LED Disk Light - LP-DL505



Adjustable
CCT
2700K / 3000K / 3500K
4000K / 5000K

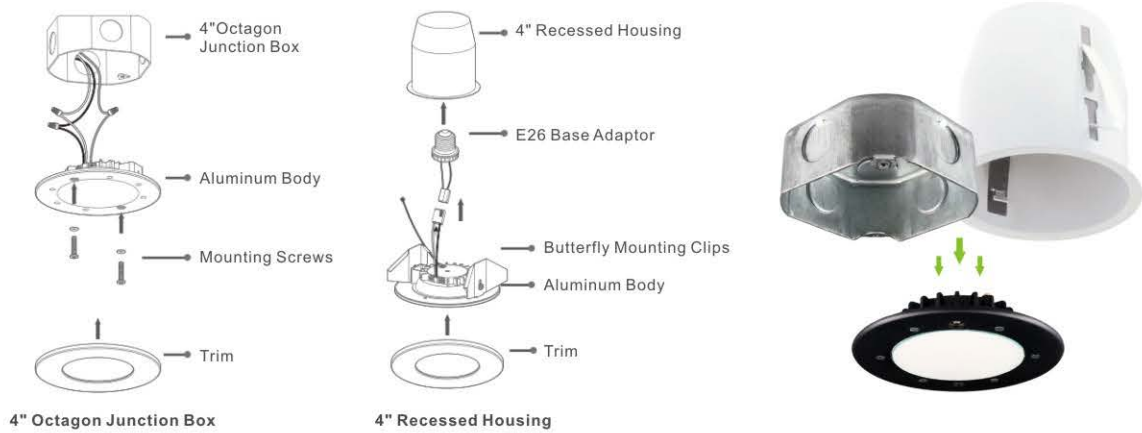

Package Includes White Magnetic Trim Other Stock Colors are Black and Brushed Nickel Sold As Accessories
Available Trims by Custom Order: Brushed Copper, Chrome

DESCRIPTION

4" Multi LED - Fits in J-Box or Can
Recessed Fixture Look Due to Very Thin Trim
Magnetic Trims with Optional Colors

FEATURES & BENEFITS

Meets Fire Rating Code When Used in a Fire Rated J-Box
Wet Location - Suitable for Showers & Outdoor
5CCT User Selectable or Single Light Color (3K or 4K) Options
CRI 90+ for True Color Rendering

DIMENSIONS ID 3 1/2" OD 4 7/8"

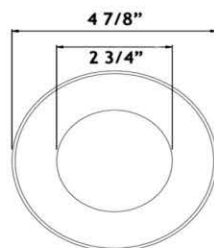
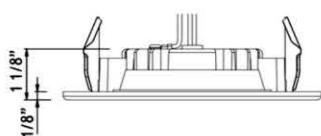

LED Disk Light - LP-DL506



4" Ultimate Junction Box Mount LED 5CCT
Interchangeable Magnetic Trims



Round White Round Black Square White Square Black

FEATURES & BENEFITS

Round & Square, White & Black trims
Fits in 4" octagon plastic junction boxes 2 1/8" deep
Up to 740 lm with CRI 90+ for True Color Rendering
5CCT user selectable-2700K, 3000K, 3500K, 4000K, 5000K
60° wide directional light beam for reduced glare
Fire rated when used with a fire rated junction box
Wet Location certified - could be installed in soffits
Regressed look - only 1/8" visible thin trim
Triac Dimmable down to 5%

DIMENSIONS: OD 4 7/8" ; Depth 1 1/8" ; Visible Trim Thickness 1/8"

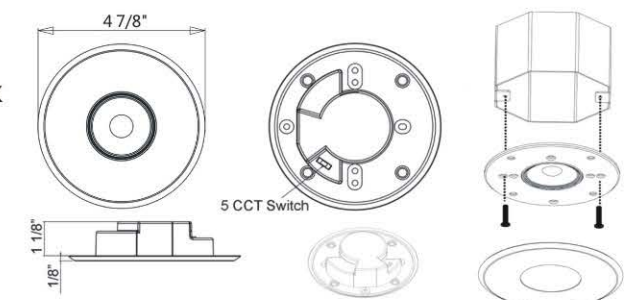



5" 7" 8" Surface Mount Backlit LED Disk
 Fast & Easy to Install in J-Box – Save on Labor
 Wet Location – Suitable For Showers & Soffits
 CRI 90+ for True Color Rendering
 Triac Dimmable Down to 10% Flicker Free
 Warranty: 3 Years

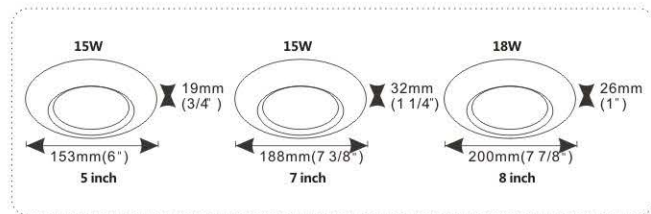

**SMART EMERGENCY BATTERY
 BACKUP LED CEILING LIGHT**



**Guarantees 2 hours operation from
 battery in case of power outage**

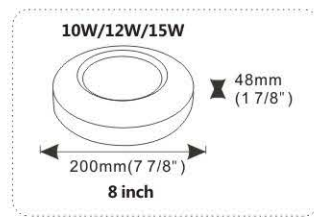
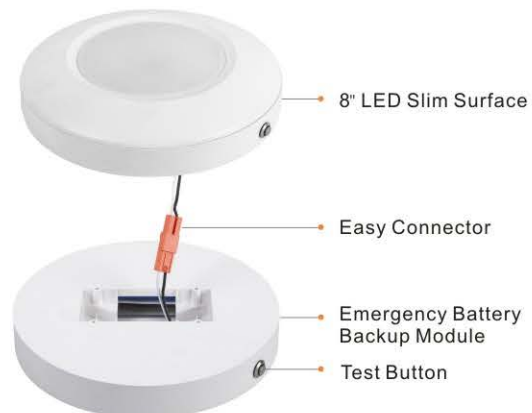

- Color Adjustment
- Works with Amazon Alexa
- Smartphone Control
- iOS/Android
- Dimming
- Timer Mode



| Model | Size | LED Chips | Watt(W) | Input Voltage | Efficacy lm/w | Beam Angle | CRI | Color Temp(K) | Lifespan(hrs) | Dimmable |
|-------|--------|-----------|---------|----------------------|---------------|------------|-----------|---------------|---------------|----------|
| MG4 | 4 inch | SMD | 9 | 100-130V 100-277V | 90 | 70° | Ra80/Ra90 | RGBCW | 50000 | Yes |
| MG6 | 6 inch | SMD | 15 | 100-347V | 90 | 70° | Ra80/Ra90 | RGBCW | 50000 | Yes |



- Trim Finish: White, Black, Brush Nickel, Chrome (Aluminum Body)
- Air Tight & IC Rated
- High Efficiency
- Driver Type: Constant Current

- 100-130V 5CCT Adjusted by DIP switch: 27K/30K/40K/50K/60K
- Bluetooth and RGB+CCT Changeable Smart Control: 27K/30K/40K/50K/60K
- Bluetooth, WiFi and RGB+CCT Changeable Smart Control: 27K/30K/40K/50K/60K





Smooth / Baffle



| Model | Size | LED Chips | Watt(W) | Input Voltage | Efficacy lm/w | Beam Angle | CRI | Color Temp(K) | Lifespan(hrs) | Dimmable |
|-------|--------|-----------|---------|----------------------|---------------|------------|-----------|---------------|---------------|----------|
| MG3 | 3 inch | SMD | 7 | 100-130V | 90 | 70° | Ra80/Ra90 | 2700-6000 | 50000 | Yes |
| MG4 | 4 inch | SMD | 9 | 100-277V 100-347V | 90 | 70° | Ra80/Ra90 | 2700-6000 | 50000 | Yes |
| MG6 | 6 inch | SMD | 15 | | 90 | 70° | Ra80/Ra90 | 2700-6000 | 50000 | Yes |

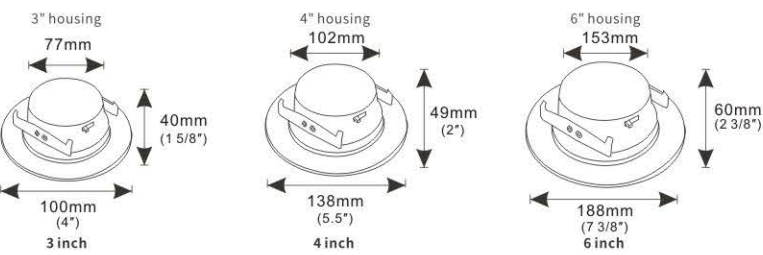

Compatible with 4inch, 5inch or 6inch LED Retrofit Housing Can



- Trim Finish: White, Black, Brush Nickel, Chrome (Iron Body)
- Air Tight & IC Rated
- High Efficiency
- Driver Type: Constant Current

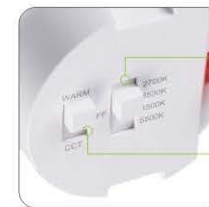

5CCT Dip Switch

Dim To Warm

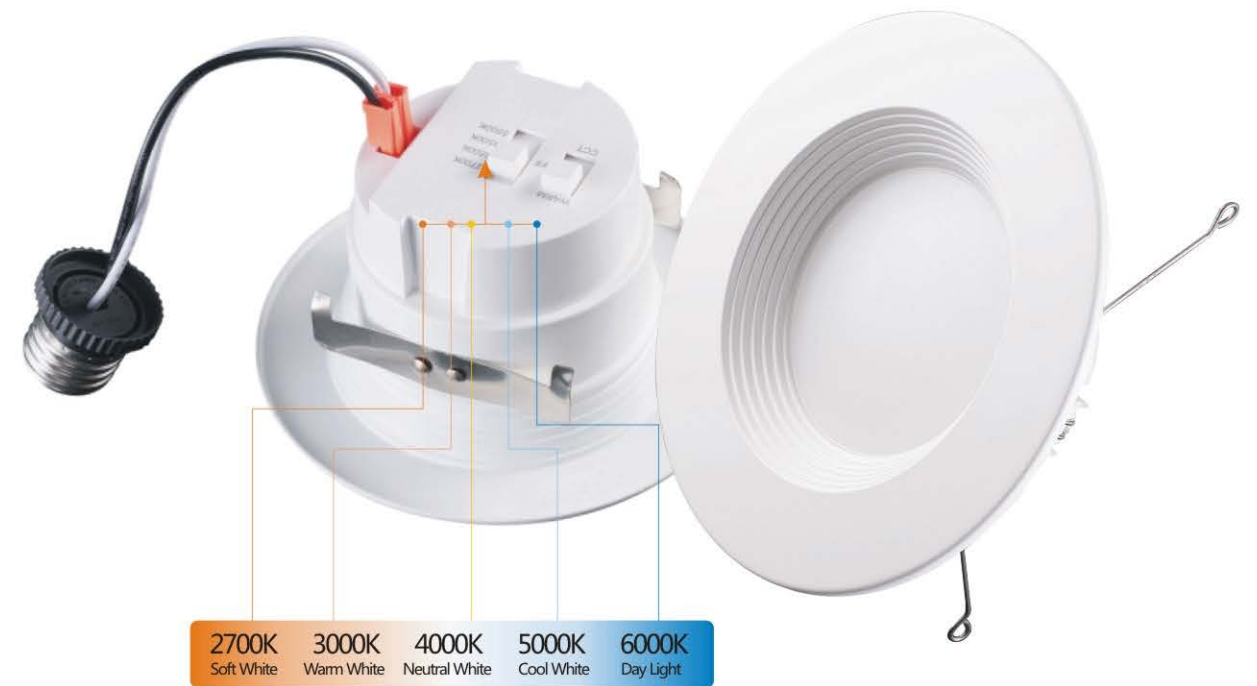

2700K Soft White 3000K Warm White 4000K Neutral White 5000K Cool White 6000K Day Light

| Model | Size | LED Chips | Watt(W) | Input Voltage | Efficacy lm/w | Beam Angle | CRI | Color Temp(K) | Lifespan(hrs) | Dimmable |
|-------|--------|-----------|---------|----------------------|---------------|------------|-----------|---------------|---------------|----------|
| MG3 | 3 inch | SMD | 7 | 100-130V | 90 | 70° | Ra80/Ra90 | 2700-6000 | 50000 | Yes |
| MG4 | 4 inch | SMD | 9 | 100-277V 100-347V | 90 | 70° | Ra80/Ra90 | 2700-6000 | 50000 | Yes |
| MG6 | 6 inch | SMD | 15 | | 90 | 70° | Ra80/Ra90 | 2700-6000 | 50000 | Yes |

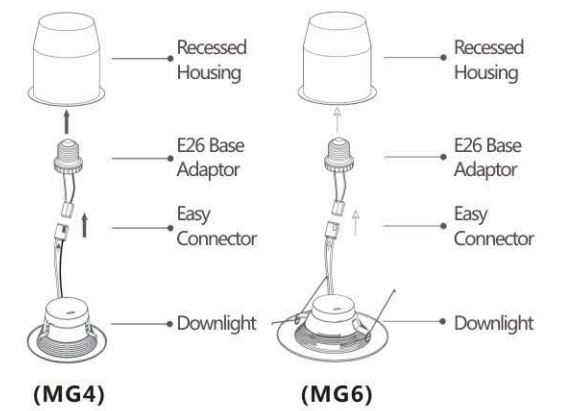
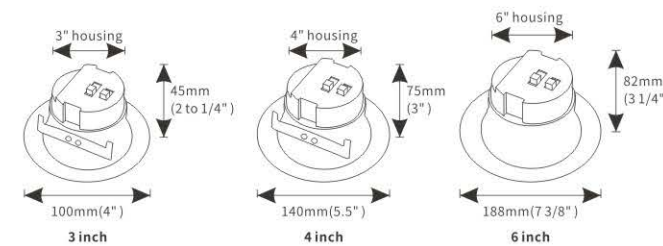

ROUND ULTRA SLIM LED FLUSH MOUNT



Switch between five color temperature modes



5 CCT With 4 Modes



| Model | Size | LED Chips | Watt(W) | Input Voltage | Efficacy lm/w | Beam Angle | CRI | Color Temp(K) | Lifespan(hrs) | Dimmable |
|---------|---------|-----------|---------|----------------------|---------------|------------|-----------|---------------|---------------|----------|
| LP-MR06 | 5 inch | SMD | 9 | | 90 | 120° | Ra80/Ra90 | 2700-6500 | 50000 | Yes |
| LP-MR07 | 7 inch | SMD | 12 | 100-130V 100-277V | 90 | 120° | Ra80/Ra90 | 2700-6500 | 50000 | Yes |
| LP-MR09 | 9 inch | SMD | 18 | 100-347V | 90 | 120° | Ra80/Ra90 | 2700-6500 | 50000 | Yes |
| LP-MR12 | 12 inch | SMD | 24 | | 90 | 120° | Ra80/Ra90 | 2700-6500 | 50000 | Yes |

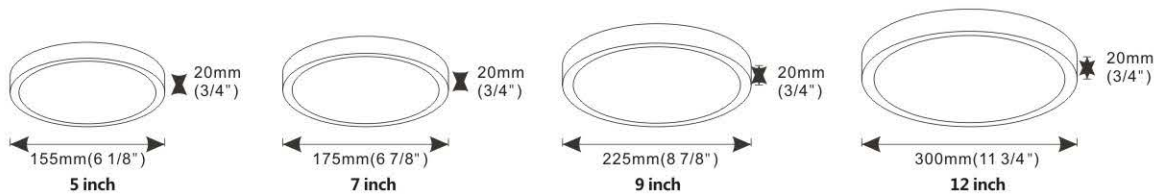

ULTRA THIN SURFACE MOUNTED LED CEILING LIGHT

Radar Sensor / Infrared Sensor



Switch between five color temperature modes power selectable



| Model | Size | LED Chips | Watt(W) | Input Voltage | Efficacy lm/w | Beam Angle | CRI | Color Temp(K) | Lifespan(hrs) | Dimmable |
|-----------|---------|-----------|----------|----------------------|---------------|------------|-----------|---------------|---------------|----------|
| LP-MR-180 | 7 inch | SMD | 8/10/12 | | 90 | 120° | Ra80/Ra90 | 2700-6000 | 50000 | Yes |
| LP-MR-218 | 8 inch | SMD | 12/15/18 | 100-130V | 90 | 120° | Ra80/Ra90 | 2700-6000 | 50000 | Yes |
| LP-MR-300 | 12 inch | SMD | 18/20/24 | 100-277V 100-347V | 90 | 120° | Ra80/Ra90 | 2700-6000 | 50000 | Yes |
| LP-MR-380 | 15 inch | SMD | 24/28/32 | | 90 | 120° | Ra80/Ra90 | 2700-6000 | 50000 | Yes |
| LP-MR-480 | 19 inch | SMD | 32/36/40 | | 90 | 120° | Ra80/Ra90 | 2700-6000 | 50000 | Yes |

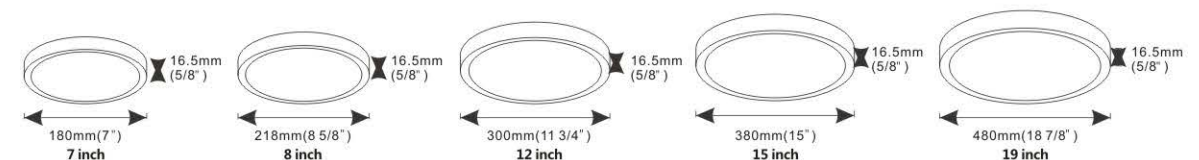

SMART EMERGENCY BATTERY BACKUP SLIM SURFACE MOUNT LIGHT FIXTURE



BATTERY BACKUP



Switch between five color temperature modes



Guarantees 2 hours operation from battery in case of power outage

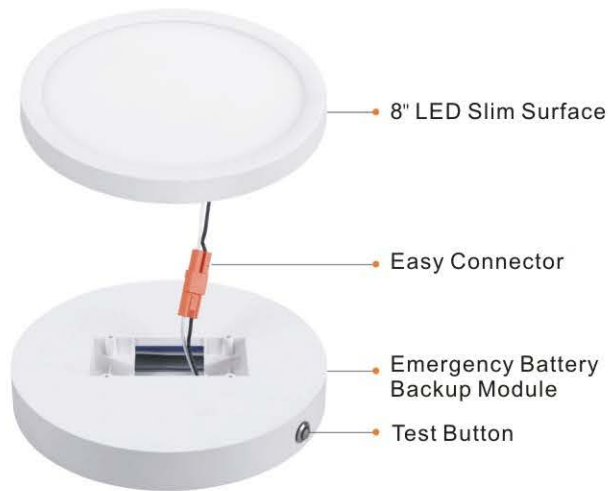

5 CCT With 4 Modes



- Trim Finish: White,Black,Brush Nickel, Chrome (Plastic Body)
- Air Tight & IC Rated
- High Efficiency
- Driver Type: Constant Current

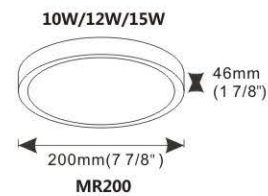

ALUMINUM CEILING LIGHT FOR PROJECT



Back-lit



| Model | Size | LED Chips | Watt(W) | Input Voltage | Efficacy lm/w | Beam Angle | CRI | Color Temp(K) | Lifespan(hrs) | Dimmable |
|--------|---------|-----------|---------|----------------------|---------------|------------|-----------|---------------|---------------|----------|
| MR409 | 4 inch | SMD | 9 | | 90 | 120° | Ra80/Ra90 | 2700-6000 | 50000 | Yes |
| MR615 | 6 inch | SMD | 15 | 100-130V 100-277V | 90 | 120° | Ra80/Ra90 | 2700-6000 | 50000 | Yes |
| MR1024 | 10 inch | SMD | 24 | 100-347V | 90 | 120° | Ra80/Ra90 | 2700-6000 | 50000 | Yes |
| MR1230 | 12 inch | SMD | 30 | | 90 | 120° | Ra80/Ra90 | 2700-6000 | 50000 | Yes |

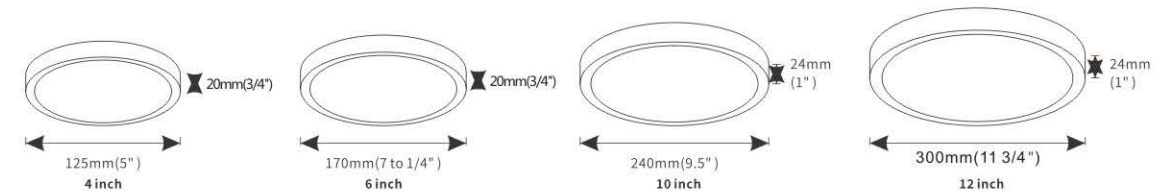

- Trim Finish: White,Black,Brush Nickel,Chrome (Aluminum Body)
- Air Tight & IC Rated
- High Efficiency
- Driver Type: Constant Current





Accessories



Hard Wire Adapter
Hard Wire Adapter to Male Quick Connect Terminal



Mounting Accessories
Mounting Accessories for 4" and 6" Recessed Housings

Junction Boxes



Octagon Steel Junction Box General Type



6" Octagon Steel Junction Boxes



3.5" & 4" Octagon Steel Junction Boxes

ZOOMABLE LED DIMMABLE TRACK LIGHT



| Model | LED Chips | Watt(W) | Input Voltage | Lumen Efficacy | Beam Angle | CRI | Color Temp(K) | Lifespan(hrs) | Dimmable |
|----------|-----------|---------|---------------|----------------|------------|-----------|---------------|---------------|----------|
| LP-GD505 | COB | 13.5W | AC100-277V | 1200lm | 24°-60° | Ra80/Ra90 | 2700-6000 | 50000 | Yes |



Available Track:
· Two Wire Track
· Three Wire Track

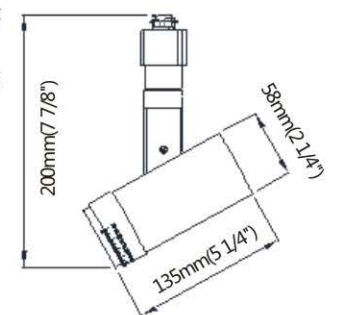

LED Track Light - LP-GD501

LED Track Light - LP-GD502

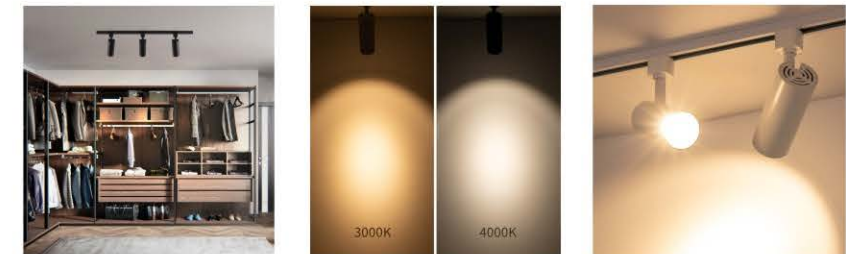

| Model | LED Chips | Watt(W) | Input Voltage | Lumen Efficacy | Beam Angle | CRI | Color Temp(K) | Lifespan(hrs) | Dimmable |
|----------|-----------|---------|---------------|----------------|------------|-----------|---------------|---------------|----------|
| LP-GD501 | COB | 6-7.5W | AC100-120V | > 76lm/w | 24°(±3°) | Ra80/Ra90 | 2700-6000 | 50000 | Yes |

| Model | LED Chips | Watt(W) | Input Voltage | Lumen Efficacy | Beam Angle | CRI | Color Temp(K) | Lifespan(hrs) | Dimmable |
|----------|-----------|---------|---------------|----------------|------------|-----------|---------------|---------------|----------|
| LP-GD502 | COB | 16.5W | AC100-120V | 1300lm | 24°(±3°) | Ra80/Ra90 | 2700-6000 | 50000 | Yes |

H System adaptor

COMPATIBLE

NOT COMPATIBLE

H Type
120V Single Circuit

Available Track:
· Two Wire Track
· Three Wire Track

H System adaptor

COMPATIBLE

NOT COMPATIBLE

H Type
120V Single Circuit

Available Track:
· Two Wire Track
· Three Wire Track

10%-100% DIMMABLE

IP65
Waterproof



**IP65 Waterproof
Pendant & Surface
Mounted Ceiling Light**

Available in Surface Mounted, Wall Mounted, Pendant

Suitable for Indoor and Outdoor IP65 Rating
Available to Black, White and Nickel Finishing
Black/White/Silver/Golden/Nickel Reflector

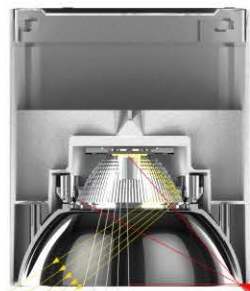

Triple Anti-glare
Waterproof Lens & Dual Optical Reflector, better Anti-glare



| Model | LED Chips | Watt(W) | Input Voltage | Efficacy lm/w | Beam Angle | CRI | Color Temp(K) | Lifespan(hrs) | Dimmable |
|----------|-----------|---------|----------------------|---------------|-----------------|------|---------------|---------------|----------|
| LP-G0325 | COB | 10 | 100-130V 100-277V | 90/100 | 20°/40°/60° | Ra90 | 2700-6000 | 50000 | Yes |
| LP-G0325 | COB | 15 | | 90/100 | 20°/40°/60° | Ra90 | 2700-6000 | 50000 | Yes |
| LP-G0325 | COB | 15 | 100-130V 100-277V | 90/100 | 20°/40°/60° | Ra90 | 2700-6000 | 50000 | Yes |
| LP-G0325 | COB | 20 | | 90/100 | 20°/40°/60° | Ra90 | 2700-6000 | 50000 | Yes |
| LP-G0325 | COB | 30 | 100-130V 100-277V | 90/100 | 20°/40°/60° | Ra90 | 2700-6000 | 50000 | Yes |
| LP-G0325 | COB | 40-50 | | 90/100 | 20°/40°/60° | Ra90 | 2700-6500 | 50000 | Yes |
| LP-G0325 | COB | 50-60 | 100-130V 100-277V | 90/100 | 20°/40°/60° | Ra90 | 2700-6500 | 50000 | Yes |
| LP-G0325 | COB | 60-100 | | 90/100 | 20°/30°/45°/60° | Ra90 | 2700-6500 | 50000 | Yes |

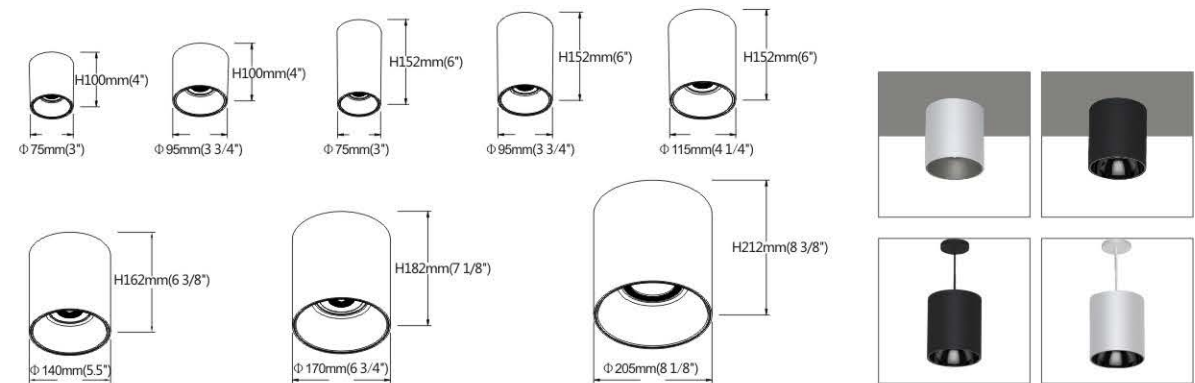

Optical Reflector





| Model | Size(mm) | Cut out(mm) | LED Chips | Watt(W) | Input Voltage | Efficacy lm/w | CRI | Color Temp(K) | Lifespan(hrs) |
|-------------|--------------|-------------|-----------|---------|----------------------------------|---------------|-----------|---------------|---------------|
| LP-1GS6615 | L45*W45*H50 | 37*37 | SMD | 2 | 100-130V 100-277V 100-347V | 90/100 | Ra80/Ra90 | 2700-5000 | 50000 |
| LP-2GS6615 | L75*W45*H50 | 67*37 | SMD | 2*2 | | 90/100 | Ra80/Ra90 | 2700-5000 | 50000 |
| LP-3GS6615 | L94*W45*H40 | 86*36 | SMD | 2*3 | | 90/100 | Ra80/Ra90 | 2700-5000 | 50000 |
| LP-5GS6615 | L147*W45*H50 | 139*37 | SMD | 2*5 | | 90/100 | Ra80/Ra90 | 2700-5000 | 50000 |
| LP-6GS6615 | L173*W45*H40 | 162*35 | SMD | 2*6 | | 90/100 | Ra80/Ra90 | 2700-5000 | 50000 |
| LP-10GS6615 | L279*W45*H50 | 272*37 | SMD | 2*10 | | 90/100 | Ra80/Ra90 | 2700-5000 | 50000 |
| LP-12GS6615 | L332*W45*H40 | 325*35 | SMD | 2*12 | | 90/100 | Ra80/Ra90 | 2700-5000 | 50000 |
| LP-15GS6615 | L411*W45*H50 | 403*37 | SMD | 2*15 | | 90/100 | Ra80/Ra90 | 2700-5000 | 50000 |

15°/30°/45° (Regular Reflector: 30°)
15°/24°/38° (Regular Len: 24°)



Different Color Reflector Available



Adjustable Angle



| Model | Size(mm) | Cut out(mm) | LED Chips | Watt(W) | Input Voltage | Efficacy lm/w | CRI | Color Temp(K) | Lifespan(hrs) |
|-------------|--------------|-------------|-----------|---------|----------------------------------|---------------|-----------|---------------|---------------|
| LP-1GS6618 | L59*W59*H50 | 53*50 | SMD | 2 | 100-130V 100-277V 100-347V | 90/100 | Ra80/Ra90 | 2700-5000 | 50000 |
| LP-2GS6618 | L88*W59*H50 | 82*50 | SMD | 2*2 | | 90/100 | Ra80/Ra90 | 2700-5000 | 50000 |
| LP-3GS6618 | L105*W60*H50 | 98*50 | SMD | 2*3 | | 90/100 | Ra80/Ra90 | 2700-5000 | 50000 |
| LP-5GS6618 | L158*W59*H50 | 155*50 | SMD | 2*5 | | 90/100 | Ra80/Ra90 | 2700-5000 | 50000 |
| LP-6GS6618 | L186*W60*H50 | 180*50 | SMD | 2*6 | | 90/100 | Ra80/Ra90 | 2700-5000 | 50000 |
| LP-10GS6618 | L291*W59*H50 | 285*50 | SMD | 2*10 | | 90/100 | Ra80/Ra90 | 2700-5000 | 50000 |
| LP-12GS6618 | L344*W60*H50 | 340*50 | SMD | 2*12 | | 90/100 | Ra80/Ra90 | 2700-5000 | 50000 |
| LP-15GS6618 | L426*W59*H50 | 420*50 | SMD | 2*15 | | 90/100 | Ra80/Ra90 | 2700-5000 | 50000 |

15°/30°/45° (Regular Reflector: 30°)
15°/24°/38° (Regular Len: 24°)





| Model | LED Chips | Watt(W) | Input Voltage | Lumen Efficacy | Beam Angle | CRI | Color Temp(K) | Lifespan(hrs) | Dimmable |
|----------|-----------|---------|---------------|----------------|------------|-----------|---------------|---------------|----------|
| LP-GD503 | COB | 9W | AC100-277V | > 72lm/w | 24°(±3°) | Ra80/Ra90 | 2700-6000 | 50000 | Yes |

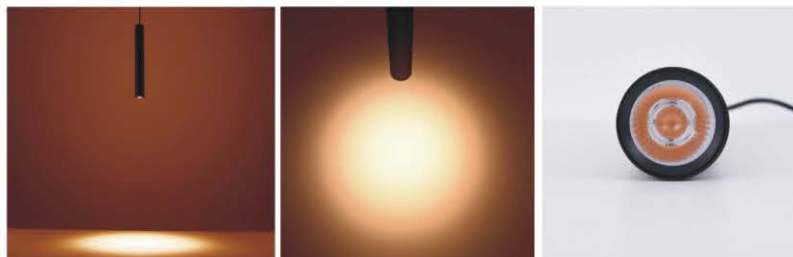
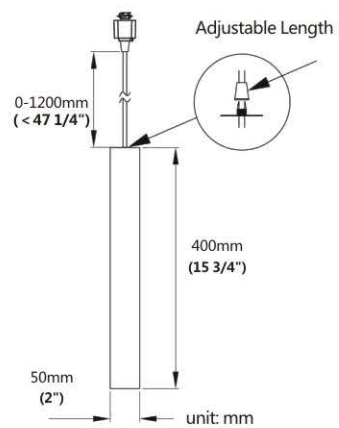

NEW CONSTRUCTION PRE-MOUNTING PLATE WITH HANGER BARS

3" Size

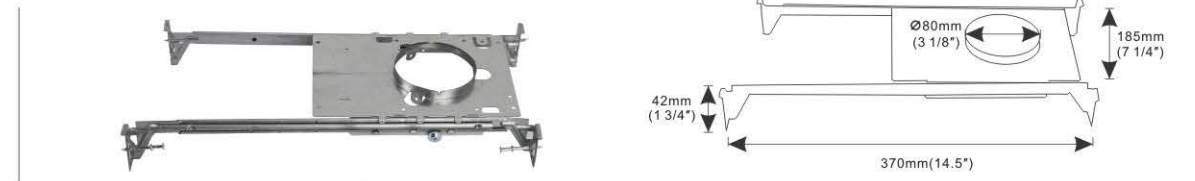

4" Size

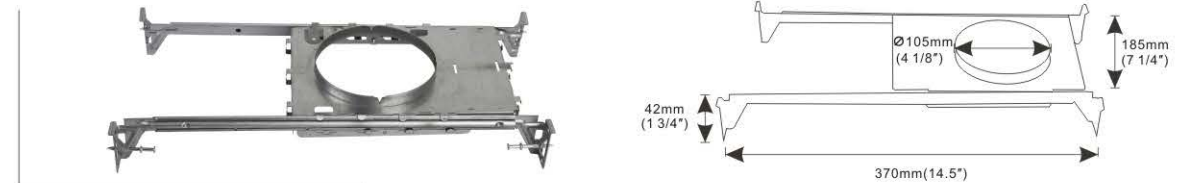

6" Size



3" 4" 6" 8" Size

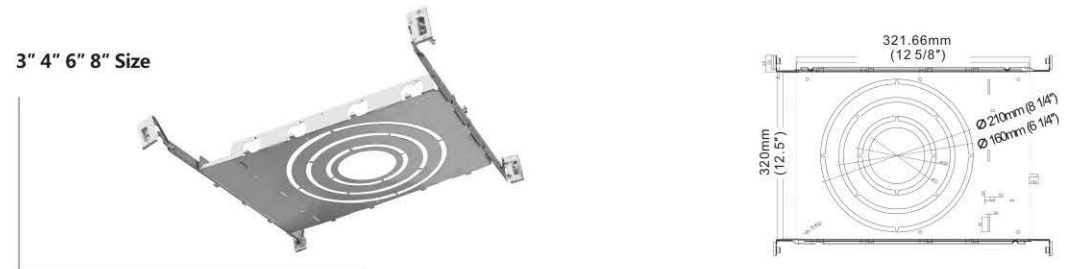

3.5" 4" 6" Size











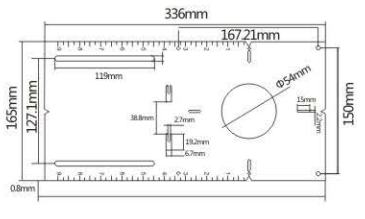

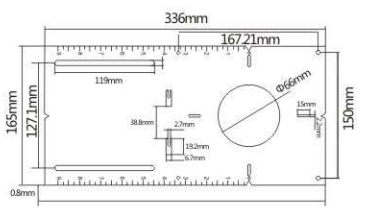

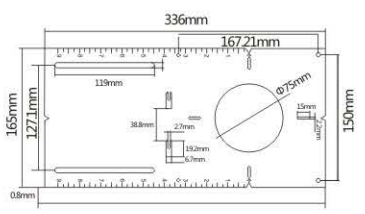
Description:

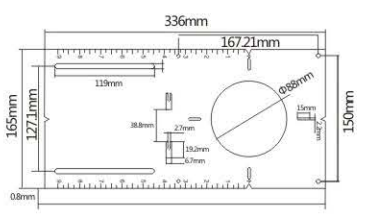

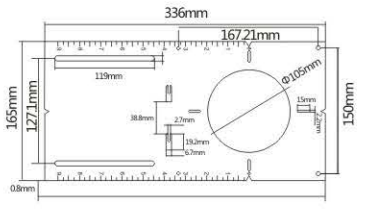

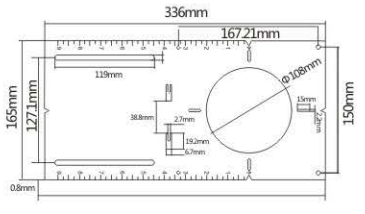

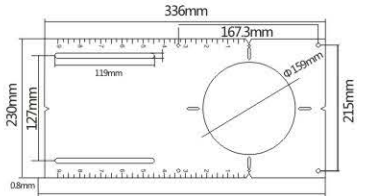



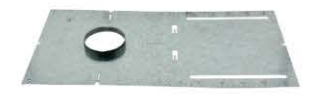
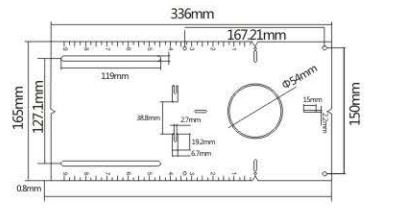

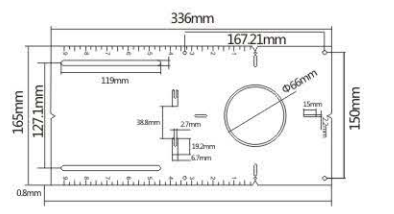
These brackets make installing ultra-thin recessed LED lights in new construction applications a breeze. Simply install the plates at your designed locations before installing the Light, have your drywallers cut/router the holes for your lights using the plate as a guide, and then snap your ultra-thin light into place after drywalling is completed.

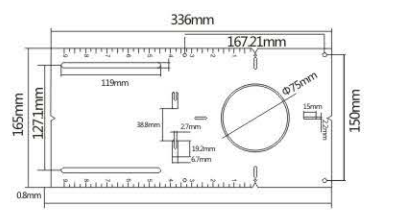
Easy to install, mount and configure Ideal for use in new-construction applications

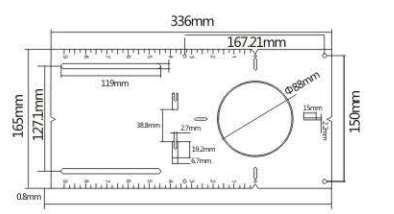
13" LONG NEW CONSTRUCTION PRE-MOUNTING PLATE

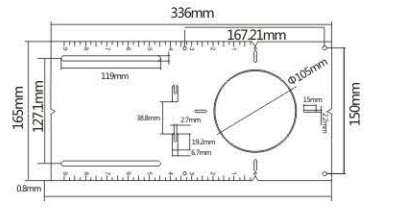
| | | |
|--|------------------------------|--|
| <p>(WITHOUT LIP)</p>  | <p>1" inch = 54mm</p> |  |
| <p>(WITHOUT LIP)</p>  | <p>2" inch = 66mm</p> |  |
| <p>(WITHOUT LIP)</p>  | <p>3" inch = 75mm/80mm</p> |  |
| <p>(WITHOUT LIP)</p>  | <p>3.5" inch = 88mm</p> |  |
| <p>(WITHOUT LIP)</p>  | <p>4" inch = 105mm</p> |  |
| <p>(WITHOUT LIP)</p>  | <p>4" inch = 108mm</p> |  |
| <p>(WITHOUT LIP)</p>  | <p>6" inch = 159mm/165mm</p> |  |

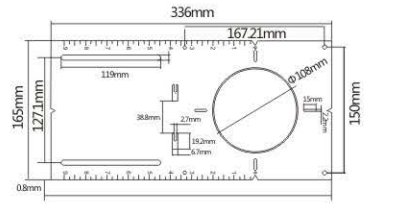
13" LONG NEW CONSTRUCTION PRE-MOUNTING PLATE

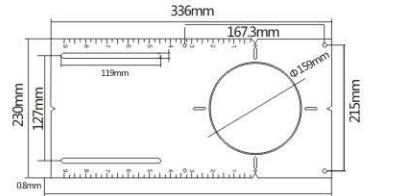
| | | |
|---|------------------------------|---|
| <p>(WITH LIP)</p>  | <p>1" inch = 54mm</p> |  |
| <p>(WITH LIP)</p>  | <p>2" inch = 66mm</p> |  |
| <p>(WITH LIP)</p>  | <p>3" inch = 75mm/80mm</p> |  |
| <p>(WITH LIP)</p>  | <p>3.5" inch = 88mm</p> |  |
| <p>(WITH LIP)</p>  | <p>4" inch = 105mm</p> |  |
| <p>(WITH LIP)</p>  | <p>4" inch = 108mm</p> |  |
| <p>(WITH LIP)</p>  | <p>6" inch = 159mm/165mm</p> |  |

26" LONG NEW CONSTRUCTION PRE-MOUNTING PLATE

26" LONG NEW CONSTRUCTION PRE-MOUNTING PLATE

(WITHOUT LIP)



1" inch = 54mm



(WITH LIP)



1" inch = 54mm

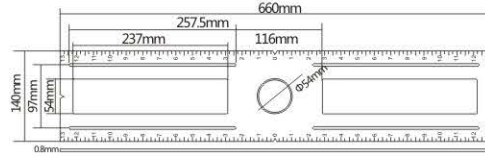

(WITHOUT LIP)



2" inch = 66mm



(WITH LIP)



2" inch = 66mm



(WITHOUT LIP)



3" inch = 75mm/80mm



(WITH LIP)



3" inch = 75mm/80mm



(WITHOUT LIP)



3.5" inch = 88mm



(WITH LIP)



3.5" inch = 88mm

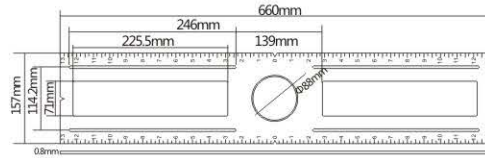

(WITHOUT LIP)



4" inch = 105mm



(WITH LIP)



4" inch = 105mm



(WITHOUT LIP)



4" inch = 108mm

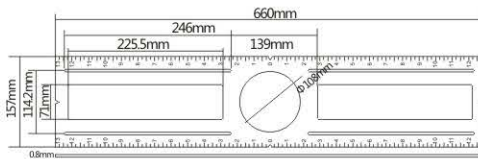

(WITH LIP)



4" inch = 108mm



(WITHOUT LIP)



6" inch = 159mm/165mm



(WITH LIP)



6" inch = 159mm/165mm

